

# 1659 RLC Digibridge®

## Instruction Manual

FORM 1659-0120-02/BI

®QuadTech, Inc., 1992  
5 Clock Tower Place, 210 East  
Maynard, Massachusetts, U.S.A. 01754  
March, 2000

Telephone 978-461-2100  
Sales 800-253-1230  
Facsimile 978-461-4295  
Website [www.quadtech.com](http://www.quadtech.com)

The material in this manual is for informational purposes only and is subject to change, without notice. QuadTech assumes no responsibility for any error or for consequential damages that may result from the misinterpretation of any procedures in this publication.

## Contents

Specifications  
Warranty  
Introduction -Section 1  
Installation -Section 2  
Operation -Section 3  
Theory -Section 4  
Service -Section 5  
Parts Lists and Diagrams -Section 6



Product will be marked with this symbol (ISO#3684) when it is necessary for the user to refer to the instruction manual in order to prevent injury or equipment damage.



Product marked with this symbol (IEC417) indicates presence of direct current.

---

# Instruction Manual Changes

---

These supplementary pages contain information of improvements or modifications not documented in the current manual. All references to GenRad in the manual now apply to QuadTech, Inc.

**Page iv -Table of Contents (Parts Lists and Diagrams -Section 6)**

Power supply assembly, board layout and schematic (pages 6-13 & 6-14) replaced by Power supply assembly part number 700011.

**Page ix -Specifications (Environment, Power Requirements & Weight)**

Power should be 90 -250Vac, 50 -60 Hz. Voltage switching is automatic and no longer selected by rear panel switch. 60 watts maximum.

Weight should be 10 lbs. (4.5 kg) net, 15 lbs. (6.8 kg) shipping.

Environment reads, Altitude < 2000m, Installation Category 1, Pollution Degree 1

**Page 1-2 -Paragraph 1.2.1,1659 RLC Digibridge**

Voltage switching is automatic and no longer selected by rear panel switch.

**Page 1-7 -Figure 1-2, Rear Controls and Connectors**

Rear view should show new power supply assembly (PN 700011) without line-voltage switch.

**Page 1-7- Table 1-2, Rear Connectors and Controls**

Ref No.1 - External bias connector receives cable (1658-2450, supplied).

Fuse is 2/10A, 250V, 3AG Type, Fast Blow. Replace only with the same type and rating.

Ref No. 3 -Air filter has been deleted.

- Ref No. 5 -  Fuse is 6/10A, 250V, 3AG Type, Slow Blow. Replace only with the same type and rating. To replace, remove fuse drawer by pressing up on release tab.

Ref No. 6 -Line-voltage switch has been deleted, power input is from 90 -250Vac.

**Page 1-10 - Table 1-3, Accessories and Options**

A quantity of two spare fuses are supplied, 6/10A, 250V, 3AG Type, Slow Blow (QuadTech part number 5330-1100)

Bias cable (1658-2450) is supplied with built-in fuse. A quantity of one spare fuse is supplied, 2/10A, 250V, 3AG Type, Fast Blow (QuadTech part number 5330-3200)

**Page 2-1 - Safety Inspection**

 Before operating the instrument inspect the power inlet module on the rear of the unit to ensure that the **properly rated fuse is in place**, otherwise damage to unit is possible. Fuse is 6/10A, 250V, 3AG Type, Slow Blow.

The 1659 is shipped with a standard U.S. power cord, QuadTech PN 4200-0300 (with Belden SPH-386 socket or equivalent, and 3 wire plug conforming to IEC 320) or an approved international cord set. Make sure the instrument is only used with these or other approved international cord sets, which ensures the instrument is provided with connection to protective earth ground.

## Instruction Manual Changes (continued)

In all installations the instrument should be positioned with consideration for ample air flow to the side and rear panel ventilation holes. An open space around the instrument of at least 3 inches (75mm) is recommend. The surrounding environment should be free from excessive dust to prevent contamination of electronic circuits.

### **WARNING**

**If this instrument is used in a manner not specified in this manual protection to the operator and equipment may be impaired.**

#### **Page 2-2 -Power-Line Connection**

Power line switch for 115V or 230V operation has been removed, switching is automatic for voltages between 90 -250Vac.

Figure 2-2 does not apply. Only certified line cords which comply with IEC 227 or IEC 245 should be used.

#### **Page 3-1 -Paragraph 3.1.2 Startup, step a .**

Power line switch for 115V or 230V operation has been removed, switching is automatic.

#### **Page 5-3 -Paragraph 5.3, Repair and Replacement of Circuit Boards**

Contacts for QuadTech: Sales & Service 800-253-1230 Technical Assistance 978-461-2100

#### **Page 5-4 -Table 5-1, Caution Note**

Power line switch for 115V or 230V operation has been removed, switching is automatic.

#### **Page 5-7 -Figure 5-1, Rear and Bottom View**

Rear view should show new power supply assembly (PN 700011) without line voltage switch.

#### **Page 5-8 - Paragraph 5.5, Disassembly and Access**

- Power Supply Assembly shown in Figure 5-3, PN 1689-2005, has been replaced by Power Supply Assembly, PN 700011.

#### **Page 5-12 -Paragraph 5.5.1, Disassembly of 1659 Digibridge, step h and i**

Delete step h, there is no longer a protective cover. CAUTION note does not apply, the fan has been removed.

Step i, the 700011 power supply is secured by only 4 screws rather than 5.

#### **Page 5-13 -Figure 5-6, Removal of Power Supply Assembly**

Power Supply Assembly shown, PN 1689-2005, has been replaced by Power Supply Assembly, PN 700011.

## **Instruction Manual Changes (continued)**

### **Page 5-18 -Instrument Cleaning Instructions**

Monthly (more or less depending on usage) the built-in test fixture should be cleaned with a soft brush and isopropyl alcohol. Avoid getting excess alcohol on instrument paint surfaces, otherwise damage to the finish can result. For additional instrument cleaning instructions refer to paragraph 5.6.1 (Care of the Test Fixture) and paragraph 5.6.3 (Care of the Display Panel).

### **Page 5-19 -Paragraph 5.6.2, Cleaning the Air Filter**

Delete paragraph, air filter has been removed.

### **Page 5-27 -Paragraph 5.7.4, Power Supply**

Trouble analysis procedure does not apply to the new Power Supply Assembly, PN 700011.

### **Page 6-2 -Figure 6-2, Rear View**

Rear view should show new power supply assembly (pN 700011) without line-voltage switch.

### **Page 6-3 -Mechanical Parts List, Rear**

Items 4 through 7 (power connector, fuse extractor post, line voltage switch and cover) deleted on new power supply assembly.

### **Page 6-13 & Page 6-14 -Parts Lists and Diagrams**

Power Supply Assembly shown, PN 1689-2005, has been replaced by Power Supply Assembly, PN 700011. The 700011 Assembly must be repaired by module exchange.

# Table of Contents

SPECIFICATIONS . . . . .	v
WARRANTY . . . . .	x
INTRODUCTION — SECTION 1	
1.1 Purpose . . . . .	1-1
1.2 General Description . . . . .	1-2
1.2.1 1659 RLC Digibridge . . . . .	1-2
1.2.2 Interface Options . . . . .	1-2
1.2.3 References . . . . .	1-2
1.3 Controls, Indicators, Connectors . . . . .	1-2
1.4 Accessories . . . . .	1-9
Condensed Operating Instructions . . . . .	1-12
INSTALLATION — SECTION 2	
2.1 Unpacking and Inspection . . . . .	2-1
2.2 Dimensions . . . . .	2-1
2.3 Power-Line Connection . . . . .	2-2
2.4 Line-Voltage Regulation . . . . .	2-3
2.5 Test-Fixture Connections . . . . .	2-3
2.6 Bias Voltage for the DUT . . . . .	2-3
2.6.1 Internal Bias . . . . .	2-3
2.6.2 External Bias . . . . .	2-3
2.7 Handler Interface (Optional) . . . . .	2-4
2.7.1 Interface via IEEE-488 Bus . . . . .	2-4
2.7.2 Timing . . . . .	2-6
2.8 IEEE-488 Interface (Option) . . . . .	2-8
2.8.1 Purpose . . . . .	2-8
2.8.2 Interface Functions . . . . .	2-9
2.8.3 Signal Identification . . . . .	2-10
2.8.4 Codes and Addresses . . . . .	2-10
2.9 Environment . . . . .	2-13
OPERATION — SECTION 3	
3.1 Basic Procedure . . . . .	3-1
3.1.1 General . . . . .	3-1
3.1.2 Startup . . . . .	3-1
3.1.3 Zeroing . . . . .	3-2
3.1.4 Routine Measurement . . . . .	3-3
3.2 Connecting the DUT . . . . .	3-4
3.2.1 General . . . . .	3-4
3.2.2 Using Integral Test Fixture . . . . .	3-5
3.2.3 Using Test Fixture Adaptors . . . . .	3-5
3.2.4 1689-9600/-9605 Remote TF . . . . .	3-7
3.2.5 1688-9600 Extender Cable . . . . .	3-8
3.2.6 1657-9600 Extender Cable . . . . .	3-9
3.2.7 Effects Cable/Fixture Cap. . . . .	3-9
3.2.8 The 1689-9603 Tweezers . . . . .	3-10
3.2.9 1689-9606 Kelvin Clip Cable . . . . .	3-11
3.3 Measurement Parameters, etc. . . . .	3-12
3.3.1 Parameters R/Q, L/Q, C/D, C/R . . . . .	3-12
3.3.2 Equivalent Circuits . . . . .	3-13
3.3.3 Results Displayed . . . . .	3-15
3.3.4 Units, Multipliers . . . . .	3-16
3.4 Principal Test Conditions . . . . .	3-17
3.4.1 Test Frequency . . . . .	3-17
3.4.2 Test Voltage . . . . .	3-17
3.4.3 Other Conditions . . . . .	3-18
3.5 Measurement Time/Meas Ranges . . . . .	3-18
3.5.1 General . . . . .	3-18
3.5.2 Measure Rate Selection . . . . .	3-19
3.5.3 Measure Mode/Display Select . . . . .	3-19
3.5.4 Ranges, Range Changing, etc. . . . .	3-19
3.5.5 Time Required..Averaging . . . . .	3-21
3.5.6 Time Required..IEEE-488 . . . . .	3-21
3.6 Accuracy, The Limits of Errors . . . . .	3-22
3.6.1 General . . . . .	3-22
3.6.2 Averaging-Improve Accuracy . . . . .	3-23
3.6.3 Accuracy Enhancement, etc. . . . .	3-23
3.6.4 Accuracy-Holding Range . . . . .	3-23
3.7 Bias For The DUT . . . . .	3-24
3.7.1 Internal Bias . . . . .	3-24
3.7.2 External Bias . . . . .	3-24
3.8 Bin Sorting & GO/NO-GO Results . . . . .	3-26
3.8.1 Introduction to Binning . . . . .	3-26
3.8.2 Sorting Methods . . . . .	3-27
3.8.3 Limit Entry Procedure . . . . .	3-28
3.8.4 Verification Nominal/Limit . . . . .	3-31
3.8.5 Limit Meas/Bin Assignments . . . . .	3-31
3.8.6 Summary on Limit Entries . . . . .	3-32
3.9 Keyboard Lock, Function Map, etc. . . . .	3-33
3.9.1 Keyboard Lock . . . . .	3-33
3.9.2 Function Map . . . . .	3-34
3.9.3 Summary of Interrogations . . . . .	3-35
3.10 Operation With A Handler . . . . .	3-35
3.11 Data Output/Progrmm'g- IEEE-488 . . . . .	3-36
3.11.1 IEEE-488 Interface Unused . . . . .	3-36
3.11.2 Talk-Only Use . . . . .	3-36
3.11.3 Talk/Listen Use . . . . .	3-41
3.11.4 Data Output in Binary Frmt . . . . .	3-47

# Table of Contents (continued)

<p>3.12 Sample IEEE Programs . . . . . 3-50</p> <p>    3.12.1 Programming Hints . . . . . 3-50</p> <p>    3.12.2 Hewlett Packard HP85 . . . . . 3-50</p> <p>    3.12.3 Capital Equip'mt. PC-488 . . . . . 3-50</p> <p>    3.12.4 Nat'l Instru'mts GPIB-PCII 3-51</p> <p>3.13 Self Checks &amp; Failure Displays 3-51</p> <p>    3.13.1 Power-Up Self Check . . . . . 3-51</p> <p>    3.13.2 Failure Display/Sig. Overld 3-52</p> <p>    3.13.3 Failure Display/Meas Cycle 3-52</p> <p>    3.13.4 Failure Display/LC Resn'ce 3-53</p> <p><b>THEORY — SECTION 4</b></p> <p>4.1 Introduction . . . . . 4-1</p> <p>    4.1.1 General . . . . . 4-1</p> <p>    4.1.2 Brief Description . . . . . 4-1</p> <p>    4.1.3 Block Diagram . . . . . 4-2</p> <p>4.2 Principal Functions . . . . . 4-4</p> <p>    4.2.1 Elementary Measurement Crt. 4-4</p> <p>    4.2.2 Frequency &amp; Time Source . . . . . 4-5</p> <p>    4.2.3 Sine-Wave Generation . . . . . 4-6</p> <p>    4.2.4 Dual-Slope Intg. Det/Conv. . . . . 4-6</p> <p><b>SERVICE — SECTION 5</b></p> <p>5.1 Customer Service . . . . . 5-3</p> <p>5.2 Instrument Return . . . . . 5-3</p> <p>    5.2.1 Return Material . . . . . 5-3</p> <p>    5.2.2 Packaging . . . . . 5-3</p> <p>5.3 Repair/Replacement-Circuit Bds. 5-3</p> <p>5.4 Performance Verification . . . . . 5-3</p> <p>    5.4.1 General . . . . . 5-3</p> <p>    5.4.2 Performance Verif. Procedure 5-4</p> <p>5.5 Disassembly and Access . . . . . 5-8</p> <p>    5.5.1 Disassembly . . . . . 5-8</p> <p>    5.5.2 Access . . . . . 5-16</p> <p>    5.5.3 IEEE/Handler Int. Options . . . . . 5-17</p> <p>    5.5.4 Removal Multiple-Pin Pkgs. . . . . 5-17</p> <p>5.6 Periodic Maintenance . . . . . 5-18</p> <p>    5.6.1 Care of the Test Fixture . . . . . 5-18</p> <p>    5.6.2 Cleaning the Air Filter . . . . . 5-19</p> <p>    5.6.3 Care of the Display Panel . . . . . 5-19</p> <p>5.7 Trouble Analysis . . . . . 5-20</p> <p>    5.7.1 General . . . . . 5-20</p> <p>    5.7.2 Power-Up Self Check, etc. . . . . 5-22</p> <p>    5.7.3 Battery &amp; Fuse Replace'mt . . . . . 5-26</p> <p>    5.7.4 Power Supply . . . . . 5-27</p> <p>    5.7.5 Sinewave Generator Checks . . . . . 5-28</p> <p>    5.7.6 Front End Amplifiers/SWs . . . . . 5-29</p>	<p>5.8 Accuracy Verification . . . . . 5-30</p> <p>    5.8.1 General . . . . . 5-30</p> <p>    5.8.2 Capacitance Meas-Sm/Med C . . . . . 5-31</p> <p>    5.8.3 Capacitance Meas-Lg. C, Rng 4 . . . . . 5-34</p> <p>    5.8.4 Resistance Meas. Accuracy. . . . . 5-36</p> <p>    5.8.5 Inductance Meas Accuracy. . . . . 5-37</p> <p>    5.8.6 D-Measurement Accuracy. . . . . 5-39</p> <p>    5.8.7 Limit Comparison Bins . . . . . 5-41</p> <p>5.9 Recalibration . . . . . 5-43</p> <p>    5.9.1 Preparation . . . . . 5-43</p> <p>    5.9.2 Zeroing . . . . . 5-44</p> <p>    5.9.3 Recalibration for Range 4 . . . . . 5-44</p> <p>    5.9.4 Recalibration for Range 3 . . . . . 5-45</p> <p>    5.9.5 Recalibration for Range 2 . . . . . 5-46</p> <p>    5.9.6 Recalibration for Range 1 . . . . . 5-47</p> <p>    5.9.7 The K Factor Calibration . . . . . 5-48</p> <p>5.10 Internal Settings . . . . . 5-51</p> <p>    5.10.1 Address IEEE488 Interface . . . . . 5-51</p> <p>    5.10.2 Making +5Volts Available . . . . . 5-51</p> <p><b>PARTS LISTS AND DIAGRAMS — SECTION 6</b></p> <p>6.1 General . . . . . 6-1</p> <p>6.2 Reference Designations . . . . . 6-1</p> <p>6.3 Diagrams . . . . . 6-3</p> <p>    Figure 6-1 Front View . . . . . 6-2</p> <p>    Figure 6-2 Rear View . . . . . 6-2</p> <p>    Federal Supply Code for Mfg. . . . . 6-4</p> <p>    Figure 6-3 Main Bd, schm, sht1 . . . . . 6-5</p> <p>    Figure 6-4 Main Bd, layout sht1 . . . . . 6-6</p> <p>    Figure 6-5 Main Bd, layout sht2 . . . . . 6-7</p> <p>    Figure 6-6 Main Bd, schm, sht2 . . . . . 6-8</p> <p>    Figure 6-7 Main Bd, schm, sht3 . . . . . 6-9</p> <p>    Figure 6-8 Main Bd, schm, sht4 . . . . . 6-10</p> <p>    Figure 6-9 Main Bd, schm, sht5 . . . . . 6-11</p> <p>    Figure 6-10 Main Bd., schm, sht6 . . . . . 6-12</p> <p>    Figure 6-11 Main Bd., schm, sht7 . . . . . 6-12</p> <p>    Figure 6-12 Power Supply, asm . . . . . 6-13</p> <p>    Figure 6-13 Power Supply, layout . . . . . 6-14</p> <p>    Figure 6-14 Power Supply, schm . . . . . 6-14</p> <p>    Figure 6-15 Display Bd, layout . . . . . 6-15</p> <p>    Figure 6-16 Display Bd, sch. sht1 . . . . . 6-16</p> <p>    Figure 6-17 Display Bd, sch. sht2 . . . . . 6-17</p> <p>    Figure 6-18 I/O Option Bd, layout . . . . . 6-18</p> <p>    Figure 6-19 I/O Option Bd, schm . . . . . 6-19</p> <p>    Figure 6-20 Keyboard Mod, asm . . . . . 6-20</p> <p>    Figure 6-21 Keyboard Indicators . . . . . 6-20</p> <p>    Figure 6-22 Keyboard, schematic . . . . . 6-21</p>
--	---

---

# Specifications

---

## 1659 RLC Digibridge

### MEASUREMENT PARAMETERS and MODES

Series or parallel R and Q, L and Q or C and D selected by the EQUIVALENT CIRCUIT key and the R/Q, L/Q and C/D keys. Continuous, triggered (single) or averaged (set of 10) measurements selected by the MODE key. The START button initiates triggered or averaged measurements. Parameter selection is initially made automatically based on the DUT being measured. Automatic selection is inhibited once a specific parameter key has been selected by the user.

### DISPLAYS: LED-TYPE NUMERICAL

When the MEASURE function has been selected, either VALUE or BIN NO. may be displayed. The VALUE display provides five digits for measured R, L or C value and four digits for D or Q with automatically positioned decimal points, units of measurement and minus signs when appropriate. The BIN NO. display provides a single digit bin assignment number based on the measured value and user entered bin limits. When the ENTER function has been selected, the display will indicate either the nominal RLC value or bin limits, entered or recalled by the user.

### MEASUREMENT RATES

Approximately 2, 4 and 8 measurements/second for the three keyboard MEASURE RATE selections SLOW, MEDIUM and FAST.

### TEST FREQUENCIES

There are four test frequencies: 100Hz, 120Hz, 1kHz or 10kHz, selected by the SHIFT and FREQUENCY keyboard buttons. Frequency accuracy is .01%

### APPLIED VOLTAGE

Ac test signal is 0.3 V rms maximum. Internal dc bias is 2 V. External dc bias of up to 60 V may be applied.

### CHARGED CAPACITOR PROTECTION

The instrument is protected from damage due to the connection of capacitors with up to one joule of stored energy.

## CALIBRATIONS

An OPEN circuit zero calibration can be performed to remove the effects of stray capacitance and conductance shunting the internal test fixture or any other fixture or cable connection. A similar SHORT circuit zero calibration can be performed to remove the effects of resistance and inductance in series in the test connections. New zero calibrations should be made to obtain best accuracy whenever the test frequency or the fixture geometry is changed. A complete recalibration of the internal standards for each measurement range may be performed by using the optional 1689-9604 Calibration Kit.

## RLC and DQ RANGES

The table below gives the overall display ranges for the two quantities measured at the same time.

Parameters	RLC Ranges	DQ Ranges
R and Q	.00001 ohm to 99999 Mohm	.0001 to 9999
L and Q	.00001 mH to 99999 H	.0001 to 9999
C and D	.00001 pF to 99999 mF	.0001 to 9999

Measurement range is automatically set by the unit for best accuracy and resolution. Automatic ranging can be inhibited by the keyboard's RANGE HOLD key.

## RLC and DQ ACCURACY

The table below gives the RLC and DQ accuracy for measurements made at the SLOW rate. The RLC accuracy given is valid when the phase angle of the component measured is low ( Q of R < 0.1, Q of 1 > 10 or D of C < 0.1). Additional factors are given below the table for other conditions.

Each RLC accuracy expression has three terms: the basic accuracy (0.1% of reading), an added fixed error which dominates when measuring very low values and an added % error term which dominates when measuring very high values.

The DQ error is fixed (i.e., not a percent), and the expression given holds over the RLC ranges where the added low value or high value RLC error terms are negligible.

These accuracy specifications assume that an OPEN and SHORT zeroing calibrations have been made at the selected test frequency.



### RLC Accuracy

Parameters & Freq	Basic Accuracy	Extreme Range Terms		DQ Accuracy
		Low end	High End	
R & Q, 100 & 120 Hz	+/-0.1%	+ 1 mohm	+ R/20 Mohm %	.0005(1 + Q <sup>2</sup> )
R & Q, 1kHz	+/-0.1%	+ 1 mohm	+ R/20 Mohm %	.0005(1 + Q <sup>2</sup> )
R & Q, 10 kHz	+/-0.1%	+ 1 mohm	+ R/5 Mohm %	.001(1 + Q <sup>2</sup> )
L & Q, 100 & 120Hz	+/-0.1%	+ 1.0 uH	+ L/20kH %	.0005(1 + Q <sup>2</sup> )
L & Q, 1kHz	+/-0.1%	+ 0.1 uH	+ L/2kH %	.0005(1 + Q <sup>2</sup> )
L & Q, 10kHz	+/-0.1%	+ 0.02 uH	+ L/50H %	.001(1 + Q <sup>2</sup> )
C & D, 100 & 120Hz	+/-0.1%	+ 2 pF	+ C/20mF %	.0005(1 + D <sup>2</sup> )
C & D, 1kHz	+/-0.1%	+ 0.1pF	+ C/2mF %	.0005(1 + D <sup>2</sup> )
C & D, 10kHz	+/-0.1%	+ 0.01pF	+ C/50uF %	.001(1 + D <sup>2</sup> )

### MEASUREMENT RATE FACTOR

Multiply both RLC and DQ accuracy specifications by the following based on selected measurement speed:

SLOW: 1    MEDIUM: 2    FAST: 5

### HIGH D and LOW Q EFFECTS ON RLC ACCURACY

Multiply the above RLC accuracy specifications as follows:

If Q of R is > 0.1, multiply the R accuracy by (1 + Q)  
 If Q of L is < 10, multiply the L accuracy by (1 + 1/Q)  
 If D of C is > 0.1, multiply the C accuracy by (1 + D)

where D and Q are absolute values (minus sign removed).

### DQ ACCURACY AT EXTREME RLC RANGE

When a High End or Low End RLC error term is not small compared to the basic 0.1% accuracy, multiply the above D or Q accuracies by the RLC accuracy (in percent) divided by 0.1%

### SORTING

10 Bins: 8 pairs of RLC limits, one DQ limit, one fail bin. GO/NO-GO lights.

### DUT CONNECTIONS

There is a built-in test fixture which will accept most common axial and radial leaded components. Four terminal (Kelvin) connections are made to the DUT.

## KEYBOARD LOCK

The keyboard can be locked to prevent inadvertent changes to test conditions and sorting routines.

## PARAMETER STORAGE

All keyboard setting and programmed nominal values and bin limits can be stored in non-volatile memory for automatic reentry upon power-up.

## SELF-CHECK DIAGNOSTICS

Self-tests are performed during power-up to verify proper operation and validity of calibration. Coded error signals on the display notify the operator if a problem is encountered.

## INTERFACE OPTION

IEEE-488 Bus and Handler Interface Option (1658-9620).

IEEE-488 Bus : All keyboard functions are programmable from the bus except for external bias control and internal standard recalibration. All RLC, DQ and bin data are available as outputs to the bus. Output data format is ASCII or Binary. The following functions, per IEEE-488, have been implemented:

AH1 Acceptor Handshake (Listener)  
SH1 Source Handshake (Talker)  
T5 Talker with normal and talk only modes (switch selectable).  
L4 Listener  
SR1 Service Request  
RL2 Remote/Local  
PP0 No Parallel Poll  
DC1 Device Clear  
DT1 Device Trigger  
CO No controller functions

Handler Outputs: Sorting results; Bins 0 thru 9 (10 lines)  
ACQ OVER; (1 line) indicates end of data acquisition (component can be moved without affecting measurement results)  
EOT; (1 line) indicates end of test and that valid bin numbers for sorting are available.  
Outputs are active low (open collector drivers rated at 30 V max. Each will sink 16 mA at 0.4 V. External power and pull-up resistors are required.

Handler Inputs: Start; (1 line) To initiate measurement.  
Input is active low ( $0V \leq v_1 \leq 0.4V$ ,  $+2.5V \leq V_h \leq +5V$ )

## **ENVIRONMENT**

Operating; 0 to 50 degrees C, < 85% RH  
Double specifications below 15 and above 35 degrees C.  
Storage; -40 to + 74 degrees C.

## **ACCESSORIES SUPPLIED**

Power cord, axial-lead adaptors, bias cable and instruction manual.

## **ACCESSORIES AVAILABLE**

IEEE/Handler Interface, 1658-9620 (see above)  
BNC Adaptor, 1689-9601  
Extender Cable with alligator clips and banana jacks, 1657-9600  
Extender Cable with Kelvin Clips, 1689-9606  
Extender Cable with 874 connectors, 1688-9600  
Extender Cable BNC to BNC, 1689-9602  
SMD tweezers, 1689-9603  
Remote Test Fixtures, 1689-9600 or 1689-9605  
Calibration Kit, 1689-9604

## **POWER REQUIREMENTS**

90 to 125 V or 180 to 250 Vac, 50 to 60 Hz.  
Voltage selected by rear panel switch. 50 W maximum.

## **MECHANICAL DIMENSIONS**

(W x H x D): 14.8" x 4.4" x 13.5" (375 x 112 x 343 mm)  
Weight: 13 lbs. (5.9 kg) net, 18 lbs. (8.2 kg) shipping

---

# Warranty

---



QuadTech warrants that Products are free from defects in material and workmanship and, when properly used, will perform in accordance with QuadTech's applicable published specifications. If within one (1) year after original shipment it is found not to meet this standard, it will be repaired, or at the option of QuadTech, replaced at no charge when returned to a QuadTech service facility.

**Changes in the Product not approved by QuadTech shall void this warranty.**

**QuadTech shall not be liable for any indirect, special or consequential damages, even if notice has been given of the possibility of such damages.**

**This warranty is in lieu of all other warranties, expressed or implied, including, but not limited to any implied warranty or merchantability or fitness for a particular purpose.**

## SERVICE POLICY

QuadTech policy is to maintain product repair capability for a period of five (5) years after original shipment and to make this capability available at the then prevailing schedule of charges.

---

# Introduction – Section 1

---

1.1	PURPOSE . . . . .	1-1
1.2	GENERAL DESCRIPTION . . . . .	1-2
1.2	CONTROLS, INDICATORS, AND CONNECTORS . . . . .	1-3
1.4	ACCESSORIES . . . . .	1-9
	CONDENSED OPERATING INSTRUCTIONS . . . . .	1-12

## 1.1 PURPOSE

The 1659 RLC Digibridge is a microprocessor- controlled, automatic, programmable RLC measuring instrument that provides accurate measurement, convenience, speed, and reliability at low cost. Limit comparison, binning, and internal bias are provided; four test frequencies are available for selection. With an interface option, the Digibridge tester can communicate with other equipment and respond to remote control.

The versatile, built-in test fixture, lighted keyboard, and informative display panel makes the Digibridge tester convenient to use. Measurement results are clearly shown with decimal points and units, which are automatically presented to assure correctness. Display resolution is 5 full digits for R, L, and C and 4 full digits for D and Q.

The basic accuracy is 0.1 %. Long-term accuracy and reliability are assured by the measurement system, which makes these accurate analog measurements over many decades of impedance without any critical internal adjustments. Calibration to account for any change of test--fixture parameters is semiautomatic; the operator needs to provide only open-circuit and short-circuit conditions in the procedure. The Digibridge tester normally autoranges and automatically identifies the principal measurement parameter.

The test fixture, with a pair of plug-in adaptors (supplied), receives any common component part (axial-lead or radial-lead), so easily that insertion of the device under test (DUT) is a one-hand operation. True 4-terminal connections are made automatically. Extender cables are available for measurements at a moderate distance from the instrument. They are optional for the 1659 (which has a built-in test fixture, but requires extension typically for bulky components or parts in an automatic handler).

Limit comparisons facilitate sorting into 8 GO and 2 NO-GO bins.

Selectable test conditions include:

- 4 Test frequencies (100 Hz, 120 Hz, 1kHz, and 10 kHz)
- Measurement speeds up to 8 per second.
- Measurement routine with averaging of 10 measurements.
- Displays: measured values, GO/NO-GO, binning.
- Automatic output of value, bin number, via IEEE-488 bus when this option is used.

Bias can be applied to capacitors being measured, either by programming the selection of an internal supply (2 V) or by sliding a switch to connect an external voltage source (up to 60 V).

The IEEE/Handler option provides full "talker/listener" and "talker only" capabilities consistent with the standard IEEE-488 bus. (Refer to the IEEE Standard 488-1978, Standard Digital Interface for Programmable Instrumentation. See para 2.8, in Section 2.) A separate connector also interfaces with component handling and sorting equipment.

## **1.2 GENERAL DESCRIPTION**

### **1.2.1 1659 RLC Digibridge**

Convenience is enhanced by the arrangement of test fixture and controls on the front ledge, with all controls for manual operation arranged on a lighted keyboard. Above and behind them, the display panel is inclined and recessed to enhance visibility of digital readouts and indicators. These indicators and those at the keyboard serve to inform and guide the operator in manipulating the simple controls, or to indicate that remote control is in effect.

The 1659 instrument stands on a table or bench top. The sturdy metal cabinet is durably finished, in keeping with the long-life circuitry inside. Glass-epoxy circuit boards interconnect and support high-quality components to assure years of dependable performance.

Adaptability to any common ac power line is assured by the removable power cord and the convenient linevoltage switch. Safety is enhanced by the fused, isolating power transformer and the 3-wire connection.

### **1.2.2 Interface Options**

The IEEE/Handler interface option adds I/O capabilities to the instrument, enabling it to control and respond to parts handling/sorting equipment. Also (via separate connector) either option can be connected in a measurement system using the IEEE-488 bus. Either "talker/listener" or "talker only" roles can be performed by the Digibridge, by switch selection.

### **1.2.3 References**

Electrical and physical characteristics are listed in Specifications at the front of this manual. Interface connections and instrument dimensions are given in Installation, Section 2. Controls are described below in Section 1; their use, in Operation, Section 3. A functional description is given in Theory, Section 4.

## **1.3 CONTROLS, INDICATORS, AND CONNECTORS**

Figure 1-1 shows the controls and indicators on the front of the 1659 instrument. Table 1-1 identifies them with descriptions and functions.

Similarly, Figure 1-2 shows the controls and connectors on the rear of the 1659 and Table 1-2 identifies them.

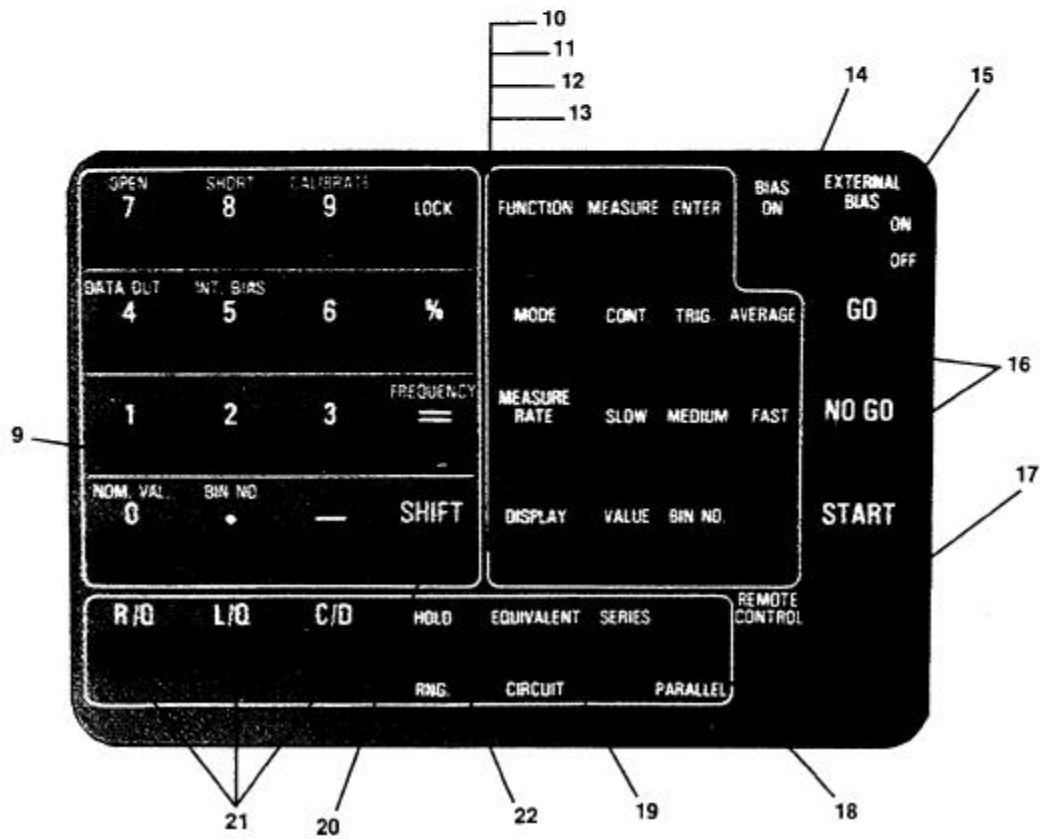
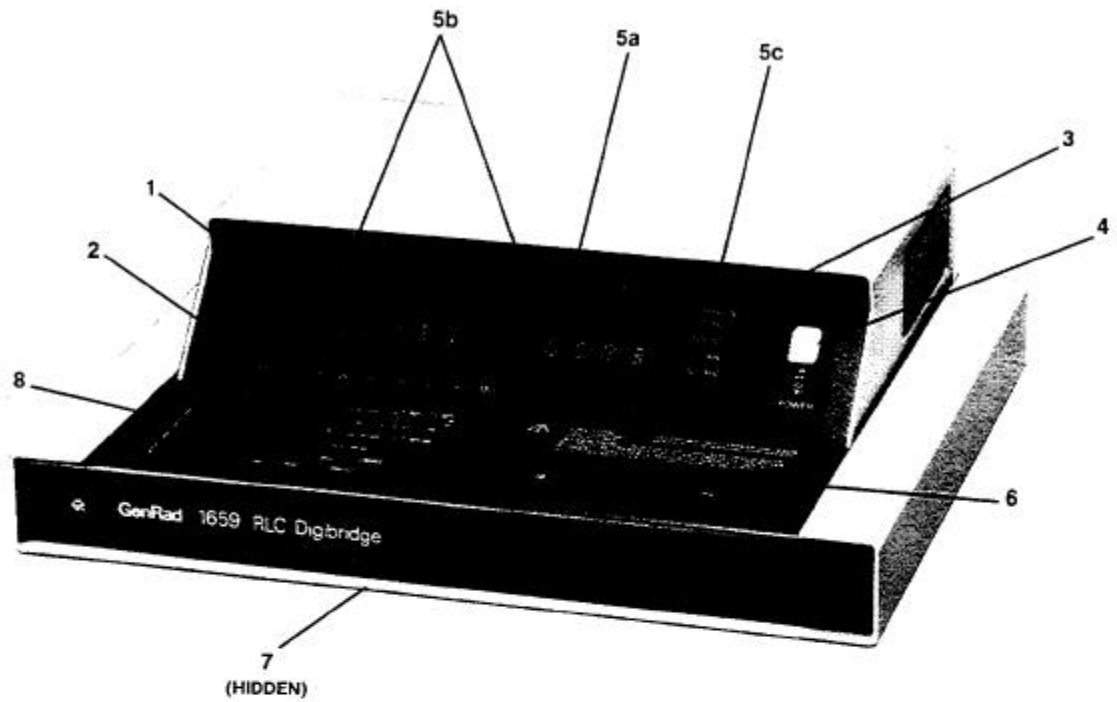

Figure 1-1. Front controls and displays.  
 Upper illustration: 1659 RLC Digibridge@. Lower illustration: keyboard detail.

**Table 1-1**  
**FRONT CONTROLS AND INDICATORS**

Fig. 1-1

Ref No.	Name	Description	Function
1	RLC display	Digital display, 5 numerals with decimal points and negative sign (-) when applicable	Display of principal measured value. If function is MEASURE and display selection is VALUE, number indicates R, L, or C. If display selection is BIN No., indicates bin assignment of measured DUT. If function is ENTER, displays are indications of programmed entries, or status in calibration sequences.
2	Units and multipliers	Light-spot (LED) indicators	Indicates measurement units associated with RLC display.
3	QD display	Digital display, 4 numerals with decimal points and negative sign (-) when applicable	If function is MEASURE, display of secondary measured value or (if display is BIN NO.) blank. If function is ENTER, RLC and QD displays together indicate programmed entries or status in calibration sequences.
4	POWER switch	Pushbutton (push again to release)	Switches the Digibridge ON (button in) and OFF (button out). OFF position breaks both sides of power circuit.
5	a). Display panel indicators	Light-spot (LED) indicators	RANGE HELD indicates that autoranging is disabled.
	b).	Light-spot (LED) indicators	Indicates display parameter selected, RLC measurement or bin assignment for principal display or QD for secondary display.
	c).	Light-spot (LED) indicators	Indicates test frequency selected, 100 Hz through 10 kHz.
6	Test fixture	Pair of special connectors; each makes dual contact with inserted wire	Receives radial-lead DUT, making 4-terminal connection automatically. Adaptors (supplied) make similar connection with axial-lead DUT. Extension cables (5-terminal) are available.
7	Reference card	Captive pull-out card	Handy reference information for basic operation: zeroing, making measurements, programming test conditions, limit entry, and bin sorting.



Table 1-1 (continued)  
FRONT CONTROLS AND INDICATORS

Fig. 1-1

Ref No.	Name	Description	Function
8	Keyboard	Group of keys, indicators, and 2 other switches	Manual programming and control. Refer to items 10 through 22 for more detail.
9	Programming keys	Set of 16 keys, labeled with white and yellow	Multipurpose input of programming instructions, selections, and data. Dual purposes of keys are indicated by color: White labels apply normally. Yellow labels apply immediately after you press and release the [SHIFT] key.
10 thru 13, 19, and 21 (See below.)		Each key has associated LED indicators	Make selection by pressing key repeatedly until the desired condition is indicated at right of the key.
10	[FUNCTION] key	Indicators MEASURE and ENTER.	Selection of function. MEASURE enables measurements and some routines that cannot be done in ENTER, such as "zero" calibrations, keyboard lock or unlock, and part of full recalibration. ENTER enables programming of nominal value and binning instructions. Note: Either function allows selection of hold range, internal bias, parameter, equivalent circuit, mode (measure mode), measure rate, and display.
11	[MODE] key	Indicators: CONT, TRIGGERED, AVG	Measurement mode selection: CONT, continuously repeating measurements; TRIGGERED, single measurement initiated by START button or input signal; AVG, reading indicates average of 10 measurements.
12	[MEASURE RATE] key	Indicators: SLOW, MED, FAST.	Selection of measurement speed as indicated. Speed is also affected by many other choices described in paragraph 3.5. Use SLOW for better accuracy; use FAST for speed.
13	[DISPLAY] key	Indicators: VALUE, BIN NO.	Selection of displays for MEASURE function; refer to items 1, 2, and 3 for description of displays.

Table 1-1 (continued)  
FRONT CONTROLS AND INDICATORS

Fig. 1-1

Ref No.	Name	Description	Function
14	BIAS ON indicator	LED indicator	Indicates that internal bias is on, or the EXTERNAL BIAS switch is ON.
15	EXTERNAL BIAS switch	Slide switch, 2 positions: ON, OFF	To connect and disconnect the external bias circuit (rear connector, cable supplied).
16	GO/NO-GO indicators	Pair of LED indicators	GO means measured value is acceptable, based on the limits previously stored. (See paragraph 3.8.) NO-GO means RLC or QD value or both are unacceptable. Indicator remains lighted during next measurement.
17	START button	Pushbutton switch.	Starts measurement sequence (aborting any measurement that may be in process). Normally used in TRIGGERED measure mode.
18	REMOTE CONTROL indicator	LED indicator	Indicates when remote control is established by external command. (Functions only if the IEEE/Handler interface option is installed.)
19	EQUIVALENT CIRCUIT key	Indicators: SERIES and PARALLEL	Selection of equivalent circuit. Measured principal R, L, C depend on this selection.
20	SHIFT key	Key labeled SHIFT	Pressing this shifts the role of any key labeled with both white and yellow FROM the white TO the other label. Do NOT hold the [SHIFT] key down; press it first, then the other key.
21	Parameter keys	Set of 3 keys, labeled: R/Q, L/Q, C/D	Selection of principal measurement parameter -- R, L, or C with secondary parameter Q or D. Repeated pushing of any one parameter key (in ENTER mode) changes range in sequence 4 3 2 1 4 ... and hence measurement units.
22	RANGE HOLD key	Key labeled: RANGE HOLD	Pressing this inhibits autoranging and holds the present range, range hold indicator will be lit.

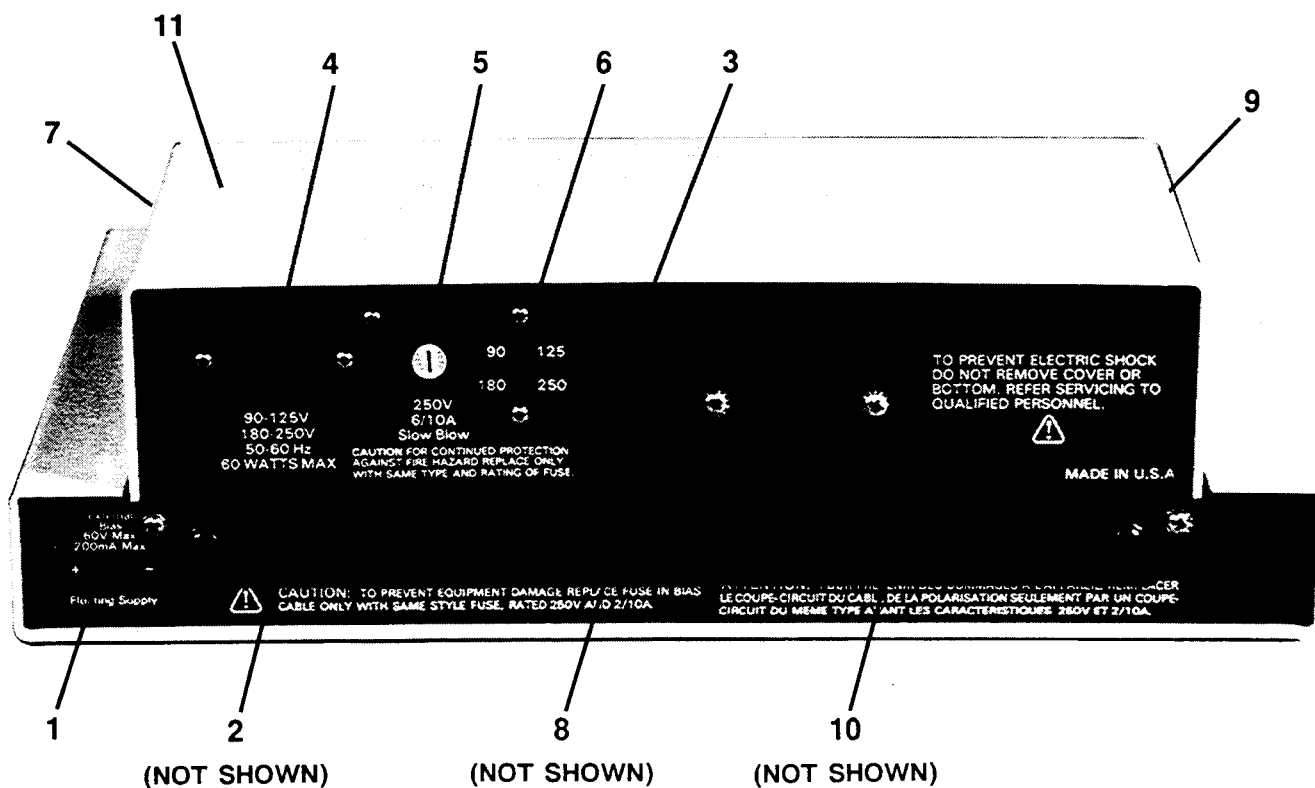

Figure 1-2. Rear controls and connectors, 1659 RLC Digibridge®.

**Table 1-2**  
**REAR CONNECTORS AND CONTROLS**

Fig. 1-2  
Ref No.

Ref No.	Name	Description	Function
1	EXTERNAL BIAS connector	Connector, 2 pins, labeled 60 V max, 200 mA max, + - .	Receives cable (1658-2450, supplied) for external bias supply. Observe the voltage and current limits and polarity.
2	TALK switch*	Toggle switch.	Selection of mode for IEEE-488 interface: TALK/LISTEN or TALK ONLY, as labeled.
3	Air filter	Porous plastic sponge	To prevent dirt from entering inlet vent.

Table 1-2  
REAR CONNECTORS AND CONTROLS (continued)

Fig. 1-2

Ref No.	Name	Description	Function
4	Power connector labeled 90-125 V, 180-250 V, 50-60 Hz, etc.	Shrouded 3-wire plug, conforming to International Electrotechnical Commission 320.	Ac power input. Use appropriate power cord, with Belden SPH-386 socket or equivalent. The GenRad 4200-0300 power cord (supplied) is rated for 125 V.
5	Fuse (labeled 250 V, 6/10 A, SLOW BLOW)	Fuse in extraction post holder	Short circuit protection. Use Bussman type MDL or equivalent fuse, 6/10 A, 250 V rating.
6	Line-voltage switch	Slide switch. Upper position: 90 to 125 V; lower position, 180 to 250 V.	Adapts power supply to line-voltage ranges, as indicated. To operate, use a small screw driver, not a sharp object.
7	Vent	Air passage	Ventilation
8	HANDLER INTERFACE connector*	Socket, 24-pin; receives Amphenol "Microribbon" plug P/N 57-30240 (or equiv).	Connections to component handler (outputs are bin numbers and status; input is a "start" signal).
9	Vent	Air passage	Ventilation
10	IEEE-488 INTERFACE connector*	Socket, 24-pin. Receives IEEE-488 interface cable. (See para 2.8).	Input/output connections according to IEEE Std 488-1978. Functions: complete remote control. Output of selected results, with or without controller.
11	Fuse (1/4 amp)	Plug-in type, sub-miniature, quick acting. Manufacturers Part No. 273.250 by Littlefuse, Inc. 800 E. Northeast Hwy., Des Plaines, IL 60016	Protects instrument circuitry from damage by charged capacitors.

\* TALK switch and 24-pin connectors are supplied with the interface option only.

## 1.4 ACCESSORIES

GenRad makes several accessories that enhance the usefulness of each Digibridge. The axial-lead adaptors (provided) convert the test fixture to a configuration well suited for axial-lead components. A choice of extender cables facilitates making connection to a parts handler or to any DUT that does not readily fit the test fixture.

Extender cables are available with your choice of banana plugs, BNC, or type 874 connectors. Each cable branches into 4 parts, for true 4-terminal connections (and guard) to the device being measured, without appreciable reduction in measurement accuracy. A remote test fixture is available to receive hand-inserted components at a distance from the Digibridge.

Other useful accessories are offered. Refer to Tables 1-3, 1-4 and inquire at the nearest Digibridge Technical Support Center. (Refer to the back of this manual.)

### NOTE

The GenRad line of Digibridge test fixtures, adaptors, and other accessories does continue to be improved and expanded. Inquire periodically at your local GenRad sales office for the latest information.

**Table 1-3**  
**ACCESSORIES AND OPTIONS FOR 1659 RLC DIGIBRIDGE®**

Quantity	Description	Part Number
1 supplied	Power cord, 200 cm (6.5 ft) long, 3-wire, AWG No. 18, with molded connector bodies. One end, with Belden SPH-386 socket, fits instrument. Other end conforms to ANSI standard C73.11-1966 (125 V max).	4200-0300
2 supplied	Test-fixture adaptors, for axial-lead parts. Replacements available: set of 4 adaptors.	1657-5995
1 supplied	Bias cable, with built-in fuse, to connect bias supply and switching circuit.	1658-2450
1 recommended	IEEE-488/handler interface option retrofit (plug-in).	1658-9620
1 recommended	Tweezers, for handling and measuring chip components with terminals on opposite faces. BNC connectors; 127-cm (50-inch) cable. Use with adaptor 1689-9601.	1689-9603
1 recommended	Extender cable for connection to parts handler, large or remote DUT, custom test fixture, etc. Length 100 cm (40 in.). One end fits test fixture of Digibridge; other end terminates in 5 stackable banana plugs.	1657-9600
1 recommended	Test-fixture adaptor, for BNC cable.	1689-9601
1 recommended	BNC cable assembly, 4 color coded cables with known "stray" parameters, 90 cm (36 in.) long.	1689-9602
1 recommended	Remote test fixture (like the fixture on the Digibridge, adaptable in many ways), with BNC connectors. (Use 1689-9601 adaptor and 1689-9602 cable.)	1689-9600

Table 1-3 (continued)  
ACCESSORIES AND OPTIONS FOR 1659 RLC DIGIBRIDGE

Quantity	Description	Part Number
1 recommended	Remote test fixture (like the 1689-9600); also has START bar, GO/NO-GO lights, which function only if the Digibridge has an interface option. Use 1689-9601 adaptor and 1689-9602 cable (as well as the 1689-2400 cable, included with this fixture).	1689-9605
1 available	Extender cable for connection to standards, large or remote DUT, custom test fixture, dielectric measurement cell, etc. Length 30 cm (12 in.). One end fits test fixture of Digibridge; other end terminates in four type 874 coaxial connectors.	1688-9600
1 recommended	Kelvin Clip cable, for testing low impedance devices that have large or non-standard termination, such as electrolytic capacitors and inductors. BNC connectors; 127 cm (50 in.) cable. Use with adaptor 1689-9601.	1689-9606
1 recommended	Calibration kit, contains six Kelvin-connected references (four precision resistances, open, and short), that plug into the built-in or 1689-9600/9605 test fixture.	1689-9604

## Condensed Operating Instructions for GenRad 1659 Digibridge

### 1 GENERAL INFORMATION

The 1659 RLC Digibridge<sup>®</sup> is a microprocessor-controlled, automatic RLC meter. It measures impedance of the device under test (DUT) and displays its parameters:  $R$ ,  $L$  or  $C$  and  $D$ , or  $Q$ . A front-panel keyboard is used to select and program measurement and test conditions. A test signal of 0.3 V at 100 Hz, 120 Hz, 1 kHz, or 10 kHz is applied to the device under test. (Default frequency is 1 kHz.) Capacitors under test can be biased with 2 V (internal d.c.) or up to 60 V (external source). Consult the instruction manual for details about operation, accuracy, specifications, and service.

### 2 START-UP

- Set line-voltage switch (rear panel) to power-line voltage.
- If the Digibridge includes an optional IEEE-488 interface, set TALK switch (rear panel) to TALK ONLY (unless instructions are to be received through the IEEE-488 bus).
- Switch EXTERNAL BIAS OFF (front panel).
- Connect power cord to source of proper voltage.
- Press POWER button "in". Self-check codes will show briefly.
- Wait until keyboard lights indicate MEASURE, VALUE, SLOW, SERIES. If a fault is detected, measurements are blocked and an error code remains displayed. (See manual, paragraph 3.13.) If keyboard lights remain dark, keyboard is locked. To unlock it, see manual paragraph 3.9. To switch power off, press POWER button and release.

### 3 ZEROING

Before measurement, zero the Digibridge as follows:

- Open Circuit.* The MEASURE keyboard light should be lit. Press [MODE] key to select TRIGGERED mode. If any test-fixture adaptors are to be used, install and position them for use. Be sure that test fixture is open circuited. Press keys: [C/D] [1] [6] [5] [9] [=] [SHIFT] [OPEN]. Keep hands and objects at least 10 cm (4 in.) from test fixture. Press START button. Wait for GO light.
- Short Circuit.* Short the fixture with a clean copper wire (AWG 18 to 30). Press [1] [6] [5] [9] [=] [SHIFT] [SHORT]. Press START button. Wait for GO light.

Note: For best accuracy, repeat this procedure every day and after any change of test-fixture adaptors.

### 4 MEASUREMENT

a. Verify or select measurement conditions as follows (indicated by keyboard lights); press the adjacent key to change a selection.

- Function: MEASURE ([FUNCTION] key)
- Display: VALUE ([DISPLAY] key)
- Measure rate: SLOW ([MEASURE RATE] key)
- Measure mode: TRIGGERED ([MODE] key)
- Equivalent circuit: SERIES ([EQUIVALENT CIRCUIT] key)

b. To measure  $C$  and  $D$  of a Capacitor ( $C$  Range .00001 pF to 99999 mF,  $D$  range .0001 to 9999): Press [C/D]. Place capacitor in test fixture. Press START. The RLC display shows  $C$  (series capacitance) and units (mF,  $\mu$ F, nF, pF); the DQ display shows  $D$  (dissipation factor). If RLC is negative, DUT is inductive.)

c. To measure  $L$  and  $Q$  of an Inductor ( $L$  range .00001 mH to 99999 H,  $Q$  range .0001 to 9999): Press [L/Q]. Place inductor in test fixture. Press START. The RLC display shows  $L$  (series inductance) and units (mH, H); the DQ display shows  $Q$  (quality factor). (If RLC is negative, DUT is capacitive.)

d. To measure  $R$  and  $Q$  of a Resistor ( $R$  range .00001  $\Omega$  to 99999 M $\Omega$ ,  $Q$  range .0001 to 9999): Press [R/Q]. Place resistor in test fixture. Press START. The RLC display shows  $R$  (series resistance) and units ( $\Omega$ , k $\Omega$ , M $\Omega$ ); the DQ display shows  $Q$  (quality factor). (If DQ is negative, DUT is capacitive; if not, DUT is inductive.)

e. Special Displays. When a nominal value and bin limits have been programmed (see Limit Entry below), these displays can be selected with the [DISPLAY] key. "BIN NO" shows the assigned bin number.

f. Other Parameters, Rates, Modes. To measure C/D, L/Q or R/Q parallel, press [EQUIVALENT CIRCUIT] to select PARALLEL. To measure faster, press [MEASURE RATE] to select MEDIUM or FAST. To measure continuously, press [MODE] to select CONT.

### 5 PROGRAMMABLE TEST CONDITIONS

(Accessible via ENTER function.)

- Press [FUNCTION] key to select ENTER function.
- Test frequency (normally 1 kHz) can be programmed by repeat keying of the [SHIFT] [FREQUENCY] keys until the appropriate indicator is lit.
- Averaging. Results of 10 measurements can be averaged. To program averaging press [MODE] key to select AVERAGE. To cancel averaging, press [MODE] key to select CONTINUOUS or TRIGGERED.
- For internal 2-volt dc bias for capacitors, press [SHIFT] [INT BIAS]. To remove internal bias, repeat [SHIFT] [INT BIAS].
- To hold a range: Measure a DUT in the range desired; or press one of the parameter keys ([R/Q] [L/Q] [C/D]) repeatedly to step through the four ranges. When the desired range is indicated (by RLC unit indicator), press [HOLD RNG]. To enable autoranging, repeat [HOLD RNG].

### 6 LIMIT ENTRY, GO/NO-GO TESTING, AND SORTING INTO BINS

- Press [DISPLAY] key to select VALUE. Press [FUNCTION] key to select ENTER.
- To enter a single DQ limit (always bin 0): press parameter key (such as [C/D]) appropriate to DUT. To change range and unit multipliers, press same key repeatedly. Enter max limit of  $D$  or  $Q$  with  $R$ ; enter min limit of  $Q$  with  $L$ , as follows. (Keyed numbers appear on left-hand display.) Example, for  $Q$  limit of 85, press [8] [5] [=] [SHIFT] [BIN NO] [0]. Value now moves to right-hand display, confirming storage of limit.

Note: If you make a mistake, press parameter key again and repeat the entry.

- To enter RLC limits for bins 1-8, three methods are given:
  - Symmetrical percentage tolerances* (nested bins). Enter nominal value of DUTs to be sorted. (The value appears on the RLC display. Units were selected in step b.) Example, for nominal value 123.40, press [1] [2] [3] [.] [4] [=] [SHIFT] [NOM VAL]. Enter for bin 1 the narrowest percent tolerance to be sorted. Example, for a tolerance of  $\pm 0.2\%$ : press [.] [2] [%] [=] [SHIFT] [BIN NO] [1]. The numerical limits for RLC are computed and rounded-off values displayed (upper limit at left, lower at right). For bin 2, enter the next wider tolerance, similarly; then bins 3 . . . 8.

- Various nominal values* (bucket sort). Plan for non-overlapping bins, each with a nominal value and limits defined by percent tolerance. For bin 1, enter nominal value and tolerance as described above. For each successive bin, similarly enter a new nominal value, then the tolerance and bin number. (Changing the nominal value does not affect limits already stored. Any DUT that qualifies for 2 overlapping bins is assigned to the lower bin.)

- Unsymmetrical tolerances.* To enter unsymmetrical limits, for example +2% -5% in bin 6: press [2] [%] [-] [5] [%] [=] [SHIFT] [BIN NO] [6]. Two percentages of the same sign can be entered. Always enter the more positive tolerance first.

- You can close any bin that has been opened (steps b, c). For RLC bins, follow this example for bin 8: press [0] [=] [SHIFT] [BIN NO] [8]. To disable DQ sorting, close bin 0 thus: for  $D$  or  $Q$ -with  $R$ , press [9] [9] [9] [9] [=] [SHIFT] [BIN NO] [0]; for  $Q$  with  $L$ , press [0] [=] [SHIFT] [BIN NO] [0].

- To enable GO/NO-GO lights after opening at least one bin, leave "nominal value" at any non-zero value. To disable GO/NO-GO and all bin sorting, press [0] [=] [SHIFT] [NOM VAL].

Note: To see present numerical limits for bin 3 and nominal value, press [SHIFT] [BIN NO] [3], and [SHIFT] [NOM VAL].

- To measure DUT with bin sorting: Press [FUNCTION] to select MEASURE, and [DISPLAY] to select BIN NO. Insert DUT. Press START. Observe GO/NO-GO and bin-number results. NO-GO indicates either DQ failure (bin 0) or RLC failure (bin 9). See manual, paragraph 3.8.



---

# Installation – Section 2

---

2.1 UNPACKING AND INSPECTION.	2-1
2.2 DIMENSIONS 2-1	2-2
2.3 POWER-LINE CONNECTION	2-3
2.4 LINE-VOLTAGE REGULATION	2-3
2.5 TEST-FIXTURE CONNECTIONS	2-3
2.6 BIAS VOLTAGE FOR THE DUT	2-3
2.7 HANDLER INTERFACE (OPTION)	2-4
2.8 IEEE-488 INTERFACE (OPTION)	2-8
2.9 ENVIRONMENT	2-13

## 2.1 UNPACKING AND INSPECTION

If the shipping carton is damaged, ask that the carrier's agent be present when the instrument is unpacked. Inspect the instrument for damage (scratches, dents, broken parts, etc.). If the instrument is damaged or fails to meet specifications, notify the carrier and the nearest GenRad field office. (See list at back of this manual.) Retain the shipping carton and the padding material for the carrier's inspection.

## 2.2 DIMENSIONS

Figure 2-1.

The instrument is supplied in a bench configuration, i.e., in a cabinet with resilient feet for placement on a table. The overall dimensions are given in Figure 2-1.

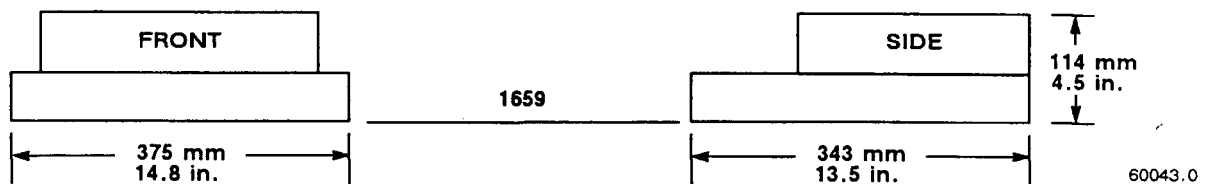

Figure 2-1. Overall dimensions of the Digibridge tester.

### 2.3 POWER-LINE CONNECTION

Figure 2-2.

The power transformer primary windings can be switched, by means of the line voltage switch on the rear panel, to accommodate ac line voltages in either of 2 ranges, as labeled, at a frequency of 50 or 60 Hz, nominal. Making sure that the power cord is disconnected, use a small screwdriver to set this switch to match the measured voltage of your power line.

If your line voltage is in the lower range, connect the 3-wire power cable (PIN 4200-0300) to the power connector on the rear panel (Figure 1-2) and then to the power line.

The instrument is fitted with a power connector that is in conformance with the International Electrotechnical Commission publication 320. The 3 flat contacts are surrounded by a cylindrical plastic shroud that reduces the possibility of electrical shock whenever the power cord is being unplugged from the instrument. In addition, the center ground pin is longer, which means that it mates first and disconnects last, for user protection. This panel connector is a standard 3-pin grounding-type receptacle, the design of which has been accepted world wide for electronic instrumentation. The connector is rated for 250 V at 6 A. The receptacle accepts power cords fitted with the Belden type SPH-386 connector.

The associated power cord for use with that receptacle, for line voltages up to 125 V, is GenRad part no. 4200-0300. It is a 200-cm (6.5 ft), 3-wire, 18-gage cable with connector bodies molded integrally with the jacket. The connector at the power-line end conforms to the "Standard for Grounding Type Attachment Plug Caps and Receptacles", ANSI C73.11-1966, which specifies limits of 125 V and 15 A. This power cord is listed by Underwriters Laboratories, Inc., for 125 V, 10 A.

If your power line voltage is in the higher range (up to 250 V), be sure to use a power cord that is approved for 250 V. The end that connects to the Digibridge tester should have a connector of the type that is on the power cord supplied; the other end, an approved connector to mate with your standard receptacle. A typical configuration for a 250-V, 15-A plug is illustrated in Figure 2-2.

If the fuse must be replaced, be sure to use a "slow blow" fuse of the current and voltage ratings shown on the rear panel, regardless of the line voltage.

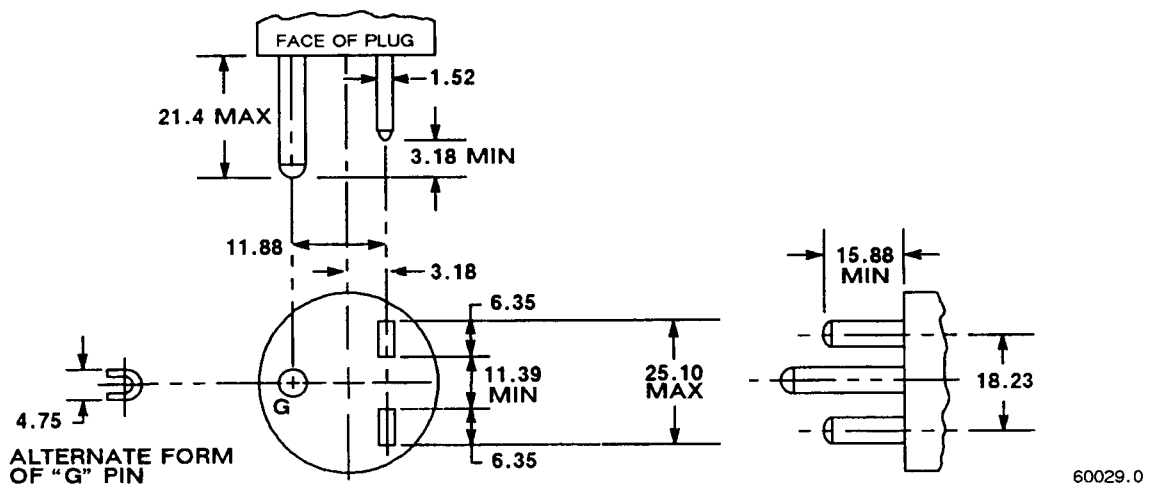

Figure 2-2. Configuration of 250-V 15-A plug. Dimensions in mm. This is listed as NEMA 6-15P. Use for example Hubbell plug number 5666.

## 2.4 LINE-VOLTAGE REGULATION

The accuracy of measurements accomplished with precision electronic test equipment operated from ac line sources can often be seriously degraded by fluctuations in primary input power. Line-voltage variations of +/-15% are commonly encountered, even in laboratory environments. Although most modern electronic instruments incorporate some degree of regulation, possible power-source problems should be considered for every instrumentation setup. The use of line-voltage regulators between power lines and the test equipment is recommended as the only sure way to rule out the effects on measurement data of variations in line voltage.

## 2.5 TEST-FIXTURE CONNECTIONS

Because an unusually versatile test fixture is provided on the front shelf of the instrument, external test fixture connections are generally NOT required. Simply plug the device to be measured (DUT) into the test fixture, with or without its adaptors. For details, refer to paragraph 3.2.

Accessory extender cables are available to connect to a DUT that is multiterminal, physically large, or otherwise unsuited for the built-in test fixture. Extender cables are needed, similarly, to connect from the Digibridge test fixture to the DUT socket in a mechanical parts handler. Cables and adaptors are listed in Table 1-3. Connection details are given in paragraph 3.2.

### NOTE

The GenRad line of Digibridge test fixtures, adaptors, and other accessories does continue to be improved and expanded. Inquire periodically at your local GenRad sales office for the latest information.

## 2.6 BIAS VOLTAGE FOR THE DUT

### 2.6.1 Internal Bias

No external connections are required for the internal 2-volt bias. The circuit is self contained.

### 2.6.2 External Bias

External bias can be provided by connecting a suitable current-limited, floating dc voltage source, as follows.

Be sure that the voltage is never more than 60 V, max.

A current limiting voltage supply is recommended; set the limit at 200 mA, max.

Be sure that the bias supply is floating; DO NOT connect either lead to ground.

A well-filtered supply is recommended. Bias-supply hum can affect some measurements, particularly if test frequency is the power frequency.

Generally the external circuit must include switching for both application of bias after each DUT is in the test fixture, and discharge before it is removed.

Connect the external bias voltage supply and switching circuit, using the 1658-2450 cable, supplied, via the rear-panel EXTERNAL BIAS connector. Observe polarity marking on the rear panel; connect the supply accordingly.

## 2.7 HANDLER INTERFACE (OPTIONAL)

### 2.7.1 Interface via IEEE-488 Bus / Handler Interface Option (1658-9620)

If you have the 1658-9620 interface option, connect from the HANDLER INTERFACE on the rear panel to a handler, printer, or other suitable peripheral equipment as follows. (The presence of the 24-pin connectors shown in Figure 1-3 verifies that you have one of the interface options). Refer to Table 1-2 for the appropriate connector to use in making a cable. Refer to Table 2-1 for the key to signal names, functions, and pin numbers.

Connect the bin control lines to the handler. See Table 2-1. Notice that the 1658-9620 IEEE-488 Bus / Handler Interface Option card provides outputs for automatic sorting into 10 bins. (Refer to paragraph 3.8.)

As indicated in the Specifications at the front of this manual, the output signals come from open-collector drivers that pull each signal line to a low voltage when that signal is active and let it float when inactive. Each external circuit must be powered by a positive voltage, up to 30 V (max), with sufficient impedance (pull-up resistors) to limit the active-signal (logic low) current to 16 mA (max).

#### CAUTION

Provide protection from voltage spikes over 30 V.

The cautionary note above means typically that each relay or other inductive load requires a clamping diode (rectifier) across it (cathode connected to the power-supply end of the load).

The input signal is also active low and also requires a positive-voltage external circuit, which must pull the signal line down below 0.4 V, but not less than 0.0 V, i.e., not negative. The logic-low current is 0.4 mA (max). For the inactive state (logic high), the external circuit must pull the signal line above +2.5 V, but not above +5 V.

#### NOTE

The "end of test" signal EOT is provided by the Digibridge only while binning is enabled, by having a non-zero "nominal value" in memory. Refer to paragraph 3.8 for details.

**Table 2-1  
HANDLER INTERFACE KEY**

Signal Name	1659-* Pin No.	Function (All signals "active low")
-----		
DC CONNECTIONS:		
----	5, 6, 7	Ground connection.
----	10	DC bus (+5 V) available; see note **
INPUT:		
START	1	Initiates measurement (single or avg).
OUTPUTS:		
EOT	18	"End of test"; bin signals are valid.***
ACQ OVER	22	"Data acquisition over"; DUT removal OK.
BIN 0	15	No-go because of D or Q limit.
BIN 1	17	Go, bin 1.
BIN 2	19	Go, bin 2.
BIN 3	21	Go, bin 3.
BIN 4	23	Go, bin 4.
BIN 5	14	Go, bin 5.
BIN 6	16	Go, bin 6.
BIN 7	20	Go, bin 7.
BIN 8	24	Go, bin 8.
BIN 9	13	No-go because of RLC limit.

-----  
\* Interface plug-in options: 1658-9620.

\*\* Low-power dc bus (+5 V) available for systems use, commonly for opto-couplers.

**CAUTION:** limit the load to 25 mA, max.

\*\*\* EOT is enabled if binning is enabled (by having a non-zero nominal value).

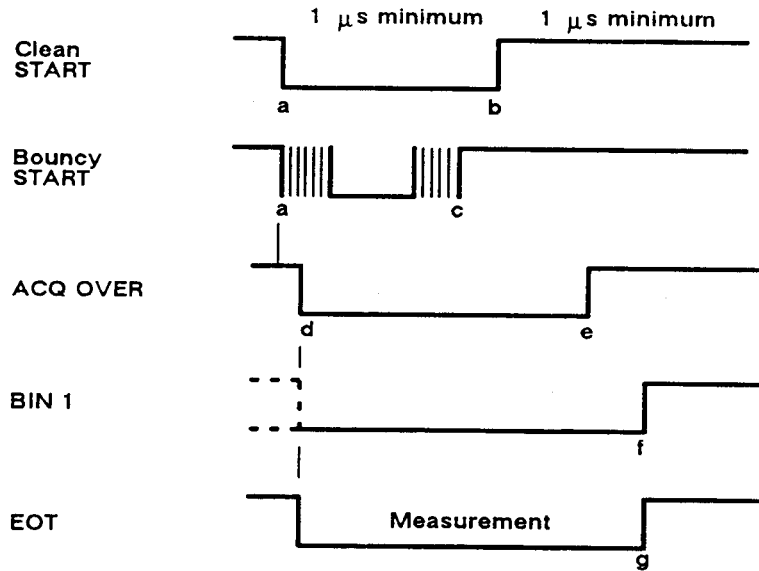

60045.0

Figure 2-3. Handler interface timing diagram.

*Notes on handler interface timing diagram, Figure 2-3.* External circuit must keep  $a-b > 1 \mu s$ , and (if START is not "debounced")  $a-c < [\text{the settling time or programmed delay}]$ . For single measurements, the DUT can be disconnected after e. The selected BIN line goes low at f; the other BIN lines stay high. AVERAGE measurement routines, ACQ OVER goes low (e) at the end of the last measurement.

### 2.7.2 Timing

Figure 2-3.

Refer to the accompanying figure for timing guidelines. Notice that START must have a duration of 1  $\mu s$  (minimum) in each state (high and low). If START is provided by a mechanical switch without debounce circuitry, the Digibridge will make many false starts; if START does not settle down (low) within the default settling time after the first transition to high, the measurement time may increase substantially.

Measurement starts at time d, which is essentially the same as time b or c; measurement is completed at g. (The START signals are expanded for clarity.) Interval a-e, during which the DUT must remain connected for data acquisition, is considerably shorter than the total measurement time a-g. The DUT can be changed after e ("indexing on ACQ", to save time) or after g ("indexing on EOT", for a simpler test setup), as explained below.

After the calculation interval e-f, measurement results are available for sorting, i.e., one of the BIN lines goes low. A few micro-seconds later, EOT goes low (can be used to set a latch holding the bin assignment). ACQ OVER, the selected BIN line, and EOT then stays low until the next start command.

The time required for measurement depends on test conditions and operating selections. Interval a-e can be less than 15 ms; the cycle a-g can be less than 40 ms; refer to paragraph 3.5 for details.

Set up the handler either of two ways: indexing on EOT or indexing on ACQ, as follows. The handler must supply a signal (here called "start next measurement") when it has completed connection of the DUT to the test fixture.

*Indexing on EDT.* Set up the handler to respond to the EOT signal from the Digibridge, which occurs at the "end of test", when the bin assignment is available for sorting. Set up the Digibridge to receive its START signal from the handler's "start next measurement" signal. This setup is simpler than the one below.

NOTE

The Digibridge requires that a non-zero value be entered for "nominal value" to enable generation of the EOT signal and indication by the GO/NO-GO lights; see paragraphs 3.8.3,3.8.4.

*Indexing on ACQ.* Set up the handler to respond to the ACQ OVER signal from the Digibridge, which occurs when the "data acquisition" is complete. The handler can then remove the DUT from the test fixture and replace it with another DUT, while the Digibridge is calculating the result.

In addition, set up an interface that provides a START signal to the Digibridge by logical combination of the EOT signal from the Digibridge AND the "start next measurement" signal from the handler. Indexing on ACQ results in higher measurement rate than indexing on EOT.

Be sure the TALK switch is set to TALK ONLY, if the IEEE-488 bus is not used.

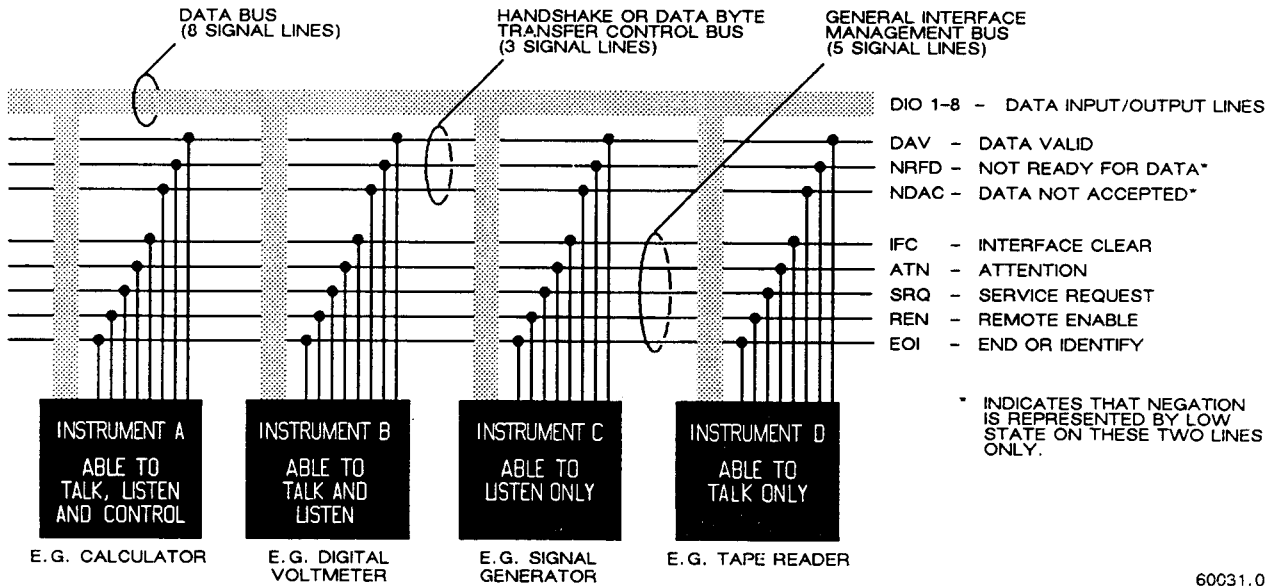

Figure 2-4. Block diagram of a generalized system interconnected by the 16-signal line bus specified in the IEEE Standard 488. Reprinted from *Electronics*, November 14, 1974; copyright McGraw-Hill, Inc., 1974.

## 2.8 IEEE-488 INTERFACE (OPTION)

### 2.8.1 Purpose

Figure 2-4.

If you have the 1658-9620 interface option, you can connect this instrument to a printer or into a system (containing a number of devices such as instruments, apparatus, peripheral devices, and generally a controller or computer) in which each component meets IEEE Standard 488-1978, Standard Digital Interface for Programmable Instrumentation. A complete understanding of this Standard (about 80 pages) is necessary to understand in detail the purposes of the signals at the IEEE-488 INTERFACE connector on the rear panel of this instrument.

#### NOTE

For copies of the Standard, order "IEEE Std 488-1978, IEEE Standard Digital Interface for Programmable Instrumentation", from IEEE Service Center, Department PB-8, 445 Hoes Lane, Piscataway, N, J.08854,

To make connection to a single device like a printer, use a IEEE-488 cable, which fits the rear-panel connector labeled IEEE-488 INTERFACE. For larger systems, each device is connected to a system bus, in parallel, usually by the use of several stackable cables. Refer to the figure for a diagram of a hypothetical system. A full set of connections is 24 (16 signals plus shield and ground returns), as tabulated below and also in the Standard. Suitable cables, stackable at each end, are available from Component Manufacturing Service, Inc., West Bridgewater, MA 02379, U.S.A. (Their part number 2024/1 is for a 1-meter-long cable.)

This instrument will function as either a TALK/LISTEN or a TALK ONLY device in the system, depending on the position of the TALK switch. "TALK/LISTEN" denotes full programmability and is suited for use in a system that has a controller or computer to manage the data flow. The "handshake" routine assures that the active talker proceeds slowly enough for the slowest listener that is active, but is not limited by any inactive (unaddressed) listener. TALK ONLY is suited to a simpler system --e.g. Digibridge and printer --with no controller and no other talker. Either mode provides measurement results to the active listeners in the system.



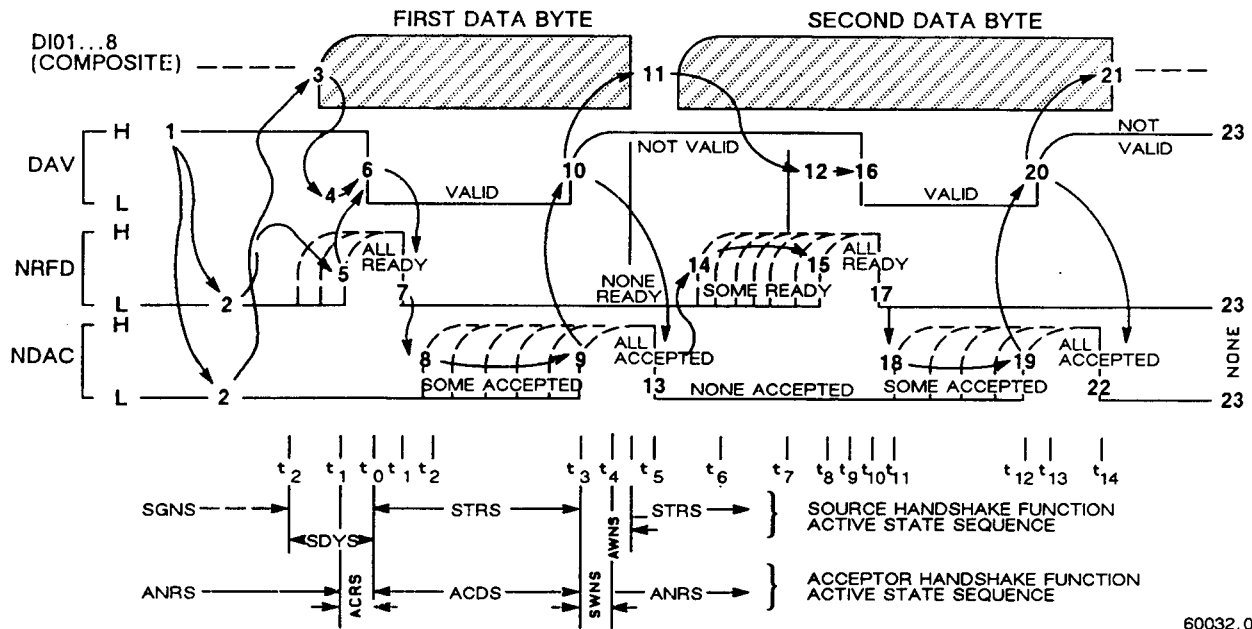

60032.0

Figure 2-5. The handshake process, illustrated by timing diagrams of the pertinent signals, for a system with one talker and several listeners. For details, refer to the standard.

## 2.8.2 Interface Functions

Figure 2-5.

The following functions are implemented. Refer to the Standard for an explanation of the function subsets, represented by the identifications below. For example, T5 represents the most complete set of talker capabilities, whereas PPO means the absence of a capability.

- SH1, source handshake (talker)
- AR1, acceptor handshake (listener)
- T5, talker (full capability, serial poll)
- L4, listener (but not listen-only)
- SR1, request by device for service from controller
- RL2, remote control (no local lockout, no return-to-local switch)
- PP0, no parallel poll
- DC, device clear
- DT1, device trigger (typically starts measurement)
- C0, no controller functions.

The handshake cycle is the process whereby digital signals effect the transfer of each data byte by means of status and control signals. The cycle assures, for example, that the data byte has settled and all listeners are ready before the talker signals "data valid". Similarly, it assures that all listeners have accepted the byte before the talker signals "data not valid" and makes the transition to another byte. Three signal lines are involved, in addition to the 8 that convey the byte itself. Refer to the accompanying figure.

### 2.8.3 Signal Identification

Refer to Table 2-2 for a key to signal names, functions, and pin numbers. Further explanation is found in the Standard. The first three signals listed take part in the "handshake" routine, used for any multiline message via the data bus; the next five are used to manage the flow of information; the last eight constitute the multiline message data bus.

### 2.8.4 Codes and Addresses

*General.* The device-dependent messages, such as instrument programming commands and measurement data (which the digital interface exists to facilitate), have to be coded in a way that is compatible between talkers and listeners. They have to use the same language. Addresses have to be assigned, except in the case of a single "talker only" with one or more "listeners" always listening. The Standard sets ground rules for these codes and addresses. In this instrument, codes for input and output data have been chosen in accordance with the rules. The address (for both talker and listener functions) is user selectable, as explained below.

*Instrument Program Commands.* The set of commands used in remote programming is an input data code to which the instrument will respond as a "talker/listener", after being set to a remote code and addressed to listen to device-dependent command strings. The set includes all of the keyboard functions except switching external bias ON/OFF and full recalibration, which are not remotely programmable. Refer to paragraph 3.11.3 for a table of the commands used in programming.

*Address.* The initial setting of address, provided by the factory, is binary 00011. Consequently, the talkaddress command (MTA) is C in ASCII code and, similarly, the listen-address command (MLA) is #. If a different address pair is desired, set it manually using the following procedure.

#### WARNING

Because of shock hazard and presence of electronic devices subject to damage by static electricity (conveyed by hands or tools), disassembly is strictly a "service" procedure.

- a. Take the Digibridge to a qualified electronic technician who has the necessary equipment for minor disassembly and adjustment. Remove the interface option assembly, as described in the 1659 Digibridge Service instructions. (There is no need to remove the top cover first.)
- b. Set the switches in "DIP" switch assembly S2 to the desired address, which is a 5-bit binary number. (See below.)
- c. Replace the interface option assembly in its former place.

Notice that S2 is located at the end of the interface option board, about 3 cm (1 in.) from the TALK switch S1. If S2 is covered, lift the cover off, exposing the "DIP" switch, which has 6 tiny switches, numbered 1 thru 6. To enter logical 1's, depress the side of each switch nearest the end of the board (switch open). To enter logical 0's, depress the other side of the switch (switch closed). The address is read from 5 to 1 (not using 6). Thus, for example, to set up the address 00011, enter 0's at positions 5, 4, 3; enter 1's at positions 2, 1. (This makes the talk address "C" and the listen address "#".) Strictly speaking, the address includes more; S2 determines only the device-dependent bits of the address. You cannot choose talk and listen addresses separately, only as a pair. The list of possible pairs is shown in Table 2-3.

**Table 2-2**  
**IEEE-488 INTERFACE KEY**

Pin No.	Signal Name	Function or Significance
6	DAV	Low state: "data is available" and valid on the DI01...DI08 lines.
7	NRFD	Low state: at least 1 listener on the bus is "not ready for data."
8	NDAC	Low state: at least 1 listener on the bus is "not done accepting data."
11	ATN	"Attention", specifies 1 of 2 uses for the DI01...DI08 lines, as follows. Low state: controller command messages. High state: data bytes from the talker device.
9	IFC	"Interface clear." Low state: returns portion of interface system to a known quiescent state.
10	SRQ	"Service request." Low: a talker or listener signals (to the controller) need for attention in the midst of the current sequence of events.
17	REN	"Remote enable." Low state: enables each device to enter remote mode when addressed to listen; (Remote-control commands are conveyed while ATN is high.) High state: all devices revert to local control.
5	EOI	"End or Identify." "END" if ATN is in high state, then, low state of EOI indicates end of a multiple-byte data transfer sequence.* "IDY" if ATN is in low state; then, low state of EOI activates a parallel poll.**
1	DI01	The 8-line data bus, which conveys interface messages (ATN low state) or device-dependent messages (ATN high state), such as remote-control commands from the controller or from a talker device.
2	DI02	
3	DI03	
4	DI04	
13	DI05	
14	DI06	
15	DI07	
16	DI08	

\* "END" is typically sent concurrently with the delimiter "linefeed" character that terminates the string(s) of data output from the Digibridge (1, 2, or 3 lines; see paragraph 2.8.4).

\*\* IDY is not implemented in this Digibridge.

**Table 2-3  
ADDRESS PAIRS AND SETTINGS FOR SWITCH S2**

Talk address		Listen address		Switch setting*
Symbol	Binary	Symbol	Binary	5 4 3 2 1
@	1 000 000	(space)	0 100 000	0 0 0 0 0
A	1 000 001	!	0 100 001	0 0 0 0 1
B	1 000 010	"	0 100 010	0 0 0 1 0
C	1 000 011	#	0 100 011	0 0 0 1 1
D	1 000 100	\$	0 100 100	0 0 1 0 0
E	1 000 101	%	0 100 101	0 0 1 0 1
F	1 000 110	&	0 100 110	0 0 1 1 0
G	1 000 111	'	0 100 111	0 0 1 1 1
H	1 001 000	(	0 101 000	0 1 0 0 0
I	1 001 001	)	0 101 001	0 1 0 0 1
J	1 001 010	*	0 101 010	0 1 0 1 0
K	1 001 011	+	0 101 011	0 1 0 1 1
L	1 001 100	,	0 101 100	0 1 1 0 0
M	1 001 101	-	0 101 101	0 1 1 0 1
N	1 001 110	.	0 101 110	0 1 1 1 0
O	1 001 111	/	0 101 111	0 1 1 1 1
P	1 010 000	0	0 110 000	1 0 0 0 0
Q	1 010 001	1	0 110 001	1 0 0 0 1
R	1 010 010	2	0 110 010	1 0 0 1 0
S	1 010 011	3	0 110 011	1 0 0 1 1
T	1 010 100	4	0 110 100	1 0 1 0 0
U	1 010 101	5	0 110 101	1 0 1 0 1
V	1 010 110	6	0 110 110	1 0 1 1 0
W	1 010 111	7	0 110 111	1 0 1 1 1
X	1 011 000	8	0 111 000	1 1 0 0 0
Y	1 011 001	9	0 111 001	1 1 0 0 1
Z	1 011 010	:	0 111 010	1 1 0 1 0
[	1 011 011	;	0 111 011	1 1 0 1 1
\	1 011 100	<	0 111 100	1 1 1 0 0
]	1 011 101	=	0 111 101	1 1 1 0 1
^	1 011 110	>	0 111 110	1 1 1 1 0

\* Do NOT set the switch to **11111**, because a talk address of "-" would be confused with an "untalk" command, and a listen address of "?", would be confused with an "unlisten" command. (ASCII code for "-" is **1 011 111** and for "?" is **0 111111**.)

In the above example, the remote message codes MLA and MTA are X0100011 and X1000011, respectively. Thus the listen address and the talk address are distinguished, although they contain the same set of device-dependent bits, which you set into S2.

*Data Output.* Data (results of measurements) are provided on the DI01...DI07 lines as serial strings of characters. Each character is a byte, coded according to the 7-bit ASCII code, as explained above. The alphanumeric characters used are appropriate to the data, for convenience in reading printouts. The character strings are always provided in the same sequence as that tabulated in paragraph 3.11.3; for example: RLC value, QDR value, bin number --if all 3 were selected (by the X7 command). The carriage-return and line-feed characters at the end of each string provide a printer (for example) with the basic commands to print each string on a separate line.

For example, if the measurement was 0.54321 uF (1 kHz, range 4 held), the character string for RLC value is:

U(space)C(space)uF(2 spaces)0.54321(CR)(LF).

If the D measurement was .001, the character string for QD value is:

(2 spaces)D(5 spaces)00.0010(CR)(LF).

If the measurement falls into bin 9, the character string for bin number is:

F(space)BIN(2 spaces)9(CR)(LF).

The character string for RLC value has the length of 17 characters; for QD value, 17 characters; for bin number, 10 characters -- including spaces, carriage-return, and line-feed characters. Refer to the format tables in paragraph 3.11.2 for details.

## 2.9 ENVIRONMENT

The Digibridge can be operated in nearly any environment that is comfortable for the operator. Keep the instrument and all connections to the parts under test away from electromagnetic fields that may interfere with measurements.

Refer to the Specifications at the front of this manual for temperature and humidity tolerances. To safeguard the instrument during storage or shipment, use protective packaging. Service personnel refer to Section 5.

When the Digibridge is mounted in a rack or other enclosed location, make sure that the ambient temperature inside the rack does not exceed the limits specified under "Environment" in the Specifications at the front of this manual, and that air can circulate freely past all air inlet and outlet vents.

---

# Operation – Section 3

---

3.1	BASIC PROCEDURE .....	3-1
3.2	CONNECTING THE DUT .....	3-4
3.3	MEASUREMENT PARAMETERS, RESULTS DISPLAYS, OUTPUTS	3 -12
3.4	PRINCIPAL TEST CONNDITIONS .....	3-17
3.5	MEASUREMENT TIME AND MEASUREMENT RANGES .....	3 -18
3.6	ACCURACY .....	3-22
3.7	BIAS FOR THE DUT .....	3-24
3.8	BIN SORTING AND GO/NO GO RESULTS .....	3-26
3.9	KEYBOARD LOCK , FUNCTION MAP AND INTERROGATIONS	3 -33
3.10	OPERATION WITH A HANDLER .....	3- 35
3.11	DATA OUTPUT AND/OR PROGRAMMING VIA IEEE-488 BUS	3-36
3.12	SAMPLE IEEE PROGRAMS .....	3-50
3.13	SELF CHECKS AND FAILURE DISPLAYS (ERROR CODES)	3 -51

## 3.1 BASIC PROCEDURE

### 3.1.1 General

For initial familiarization with the Digibridge RLC tester, follow this procedure carefully. After that, use this paragraph as a ready reference and refer to later paragraphs in this section for details. Condensed operating instructions are provided near the front of this manual.

One can also refer to the Condensed Operating Instructions, found stored in a pocket under the instrument. Reach under the front edge and pull the card forward as far as it slides easily. After use, slide it back in the pocket for protection.

### 3.1.2 Startup

#### CAUTION

Set the line voltage switch properly (rear panel) before connecting the power cord.

This is the regular startup procedure.

a. After the line-voltage switch has been set to the position that corresponds to your power-line voltage (which must be in either range: 90 to 125 V or 180 to 250 V ac, nominally 50 or 60 Hz), then connect the power cord as explained below.

*Temperature.* If the Digibridge tester has been very cold, warm it in a dry environment, allowing time for the interior to reach 0 degrees C or above, before applying power. Otherwise, the instrument may be damaged by thermal shock.

*Power Cord.* Connect the power cord to the rear-panel connector, and then to your power receptacle.

b. If the Digibridge tester includes an optional IEEE-488 interface, set TALK switch (rear panel) to TALK ONLY (unless instructions are to be received through the IEEE-488 bus).

c. Switch EXTERNAL BIAS OFF (front panel).

d. Press the POWER button "in", so that it stays in the depressed position. Self-check codes will show briefly, indicating that the instrument is automatically executing a power-up routine that includes self checks.

(To turn the instrument off, push and release the POWER button and leave it in the "out" position.)

e. Wait until keyboard lights indicate MEASURE, VALUE, SLOW, CONT (or TRIGGERED), SERIES. If they do not, there are two possible explanations: self-check fault and keyboard lock. If a fault is detected in the self-check, measurements are blocked and an error code remains displayed. Under some conditions, the block to operation can be bypassed. (See paragraph 3.13.) If the keyboard is locked, all of those keyboard indicators remain unlit except MEASURE and/or REMOTE CONTROL -and all previously programmed test conditions, limits, etc are reestablished. To unlock it, see paragraph 3.9.

### 3.1.3 Zeroing

Before measurement, zero the Digibridge as follows. In this process, the instrument automatically measures stray parameters and retains the data, which it uses to correct measurements so that results represent parameters of the DUT alone, without (for example) test-fixture or adaptor capacitance.

a. Conditions.

SLOW measure rate, RANGE HELD indicator NOT lit.

b. Open Circuit.

Press [FUNCTION] key (if necessary) to select MEASURE function.

Press [MODE] key (if necessary) to select TRIGGERED mode.

If any test-fixture adaptors are to be used, install and position them for use. (See paragraph 3.2).

Be sure that the test fixture is open circuited.

If you want this "zero" process to echo a display of 00000, press the [C /D] key. However doing so will disable automatic parameter selection. (See paragraph 3.1.4, step b.).

Press these keys deliberately: [1] [6] [5] [9] [=] [SHIFT] [OPEN].

Note: the GO indicator being lit and two zeros confirm the previous step.

Watch the GO indicator on the keyboard; not one on any remote test fixture.

Keep hands and objects at least 10 cm (4 in.) from test fixture.

Press the START button. The GO indication disappears.

Wait for the GO indicator to be lit again.

c. Short Circuit.

Short the fixture with a clean copper wire (AWG 18 to 30), length 5 to 8 cm.

Press these keys: [1] [6] [5] [9] [=] [SHIFT] [SHORT].

Note: the GO indicator being lit and two fives confirm the previous step.

Press the START button. The GO indication disappears.

Wait for the GO indicator to be lit again.

Remove the short circuit.

NOTE: For best accuracy, repeat the zeroing procedure daily and after changing test-fixture adaptors or frequency.

### 3.1.4 Routine Measurement

a. Verify or select measurement conditions as follows (indicated by keyboard lights); press the adjacent key to change a selection.

**Function:** MEASURE ([FUNCTION] key), a necessary selection

**Display:** VALUE ([DISPLAY] key), for normal RLC/QD results

**Measure rate:** SLOW ([MEASURE RATE] key), for best accuracy

**Measure mode:** TRIGGERED ([MODE] key), optional

**Equivalent circuit:** SERIES [(EQUIVALENT CIRCUIT] key) -see paragraph 3.3.

If you are in doubt about how to connect the device to be tested with the Digibridge, refer to paragraph 3.2, below.

b. To measure *any passive component* (without knowing whether it is essentially a resistor, inductor, or capacitor), use "automatic parameter selection". This feature is provided at power-up and remains enabled as long as you do NOT select any particular parameter. (Automatic parameter selection can be disabled by pressing any of the three parameter keys: R/Q, L/Q, or C/D. Once disabled, this feature can be enabled again only on a powerup.

Place DUT in test fixture. Press START. (See note below.) The RLC display and units indicator show the principal measured value and the basic parameter, thus identifying the DUT. The QD display shows the measured Q if the principal units are ohms or henries; the measured D if they are farads.

#### NOTE

Use either the Digibridge START button or the start bar on the 1689-9605 Remote Test Fixture if it is being used.

In steps c, d, e, the parameters to be measured are specified by the user.

c. To measure *C and D of a Capacitor* (C Range .00001 pF to 99999 mF, D range .0001 to 9999): Press [C/D]. Place capacitor in test fixture. Press START. The RLC display shows Cs (series capacitance) and units (mF, uF, nF, pF); the QD display shows D (dissipation factor). {If RLC is negative, DUT is inductive.}

d. To measure *L and Q of an Inductor* (L range .00001 mH to 99999 H, Q range .0001 to 9999): Press [L/Q]. Place inductor in test fixture. Press START. The RLC display shows Ls (series inductance) and units (mH, H); the QD display shows Q (quality factor). {If RLC is negative, DUT is capacitive.}

e. To measure *R and Q of a Resistor* (R range .00001 ohm to 99999 Mohms, Q range .0001 to 9999): Press [R/Q]. Place resistor in test fixture. Press START. The RLC display shows Rs (series resistance) and units (ohms, kilohms, Mohms); the QD display shows Q (quality factor). {If QD is negative, DUT is capacitive; if not, DUT is inductive.}

NOTE: This procedure is basic; there are many alternatives described later. You can select and program for other parameters, equivalent circuits, types of results displayed, test conditions, measurement rate, and bin sorting, etc.



## 3.2 CONNECTING THE DUT

### 3.2.1 General

#### WARNING

**Charged capacitors can be dangerous, even lethal. Never handle their terminals if they have been charged to more than 60 V. Routine discharging procedures may not be perfectly dependable.**

Connect the "device under test" (DUT), whose parameters are to be measured, as follows.

#### NOTE

Clean the leads of the DUT if they are noticeably dirty, even though the test-fixture contacts will usually bite through a film of wax to provide adequate connections.



Figure 3-1. A radial-lead DUT is inserted into a Digibridge test fixture.

### 3.2.2 Using the Integral Test Fixture on the 1659 Digibridge for Radial-Lead DUTs

Figure 3-1.

#### NOTE

For use of a similar *remote* test fixture, refer to paragraph 3.2.4.

If the DUT is a radial-lead component or has parallel leads at one side, insert them into the Digibridge test fixture slots as described below.

The test fixture provided on the front ledge of the 1659 Digibridge provides convenient, reliable, guarded 4-terminal connection to any common radial-lead or (with adaptors that are provided) an axial-lead component part.

The slots in the test fixture accommodate wires with diameters from 0.25 mm (.01 in., AWG 30) to 1 mm (.04 in., AWG 18), spaced from 4 to 98 mm apart (0.16 to 3.9 in.) or equivalent strip conductors. Each "radial" wire must be at least 4 mm long (0.16 in.). The divider between the test slots contains a shield, at guard potential, with its edge semi-exposed. The tapped holes (6-32 thread) at the left and right ends of the test fixture are also grounded, to connect the shields of extender cables.

#### NOTE

If any adaptor(s), described below, are in place, remove them before attempting to insert a radial-lead DUT.

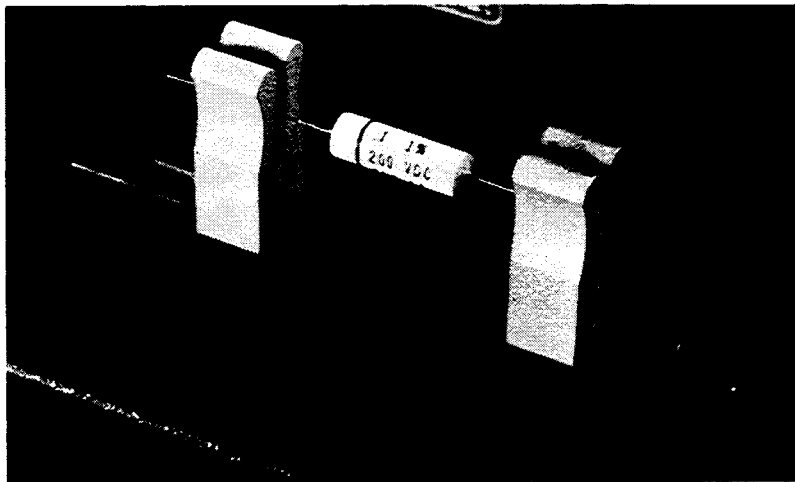

Figure 3-2. Use of adaptors (supplied) for connection of an axial-lead DUT to the Digibridge test fixture.

### 3.2.3 Using the Test-Fixture Adaptors for Axial-Lead DUTs

Figure 3-2.

If the DUT is an axial-lead component or has leads at opposite ends, insert the leads into the test-fixture adaptor's slots as shown in Figure 3-2 and described below. NOTE: This description applies to the built-in test fixture of the 1659 Digibridge and also to remote test fixtures 1689-9600 and 1689-9605.

Install the test-fixture adaptors, supplied, as shown; put one in each slot of the test fixture, by pushing vertically downward. Slide the adaptors together or apart so the body of the DUT will fit easily between them.

Notice that the contacts inside the adaptor are off center; be sure to orient the adaptors so the contacts are close to the body of the DUT, especially if it has short or fragile leads.

The adaptors accommodate wires with diameters up to 1.5 mm (.06 in., AWG 15). The body of the DUT that will fit between these adaptors can be 80 mm long and 44 mm diameter (3.1 x 1.7 in.) maximum. Each "axial" wire must be at least 3 mm long (0.12 in.). The overall length of the DUT, including the axial wires must be at least 22 mm (0.866 in.).

Insert the DUT so that one lead makes connection on the left side of the test fixture, the other lead on the right side. Insertion and removal are smooth, easy operations and connections are reliable if leads are reasonably clean and straight. Press the DUT down so that the leads enter the slots in the adaptors as far as they go easily.

Be sure to remove any obvious dirt from leads before inserting them. The test-fixture contacts will wipe through a film of wax, but can become clogged and ineffectual if dirty leads are inserted repeatedly.

Be sure to insert only one thing into each half of the test fixture, at anyone time. (If any object is inserted into the same slot with a DUT lead, it will probably NOT make true "Kelvin" connections.)

#### NOTE

For a DUT with very short leads, it is important to orient each adaptor so that its internal contacts (which are off center) are close to the DUT. To remove each adaptor, lift with a gentle tilt left or right (never forward or back).

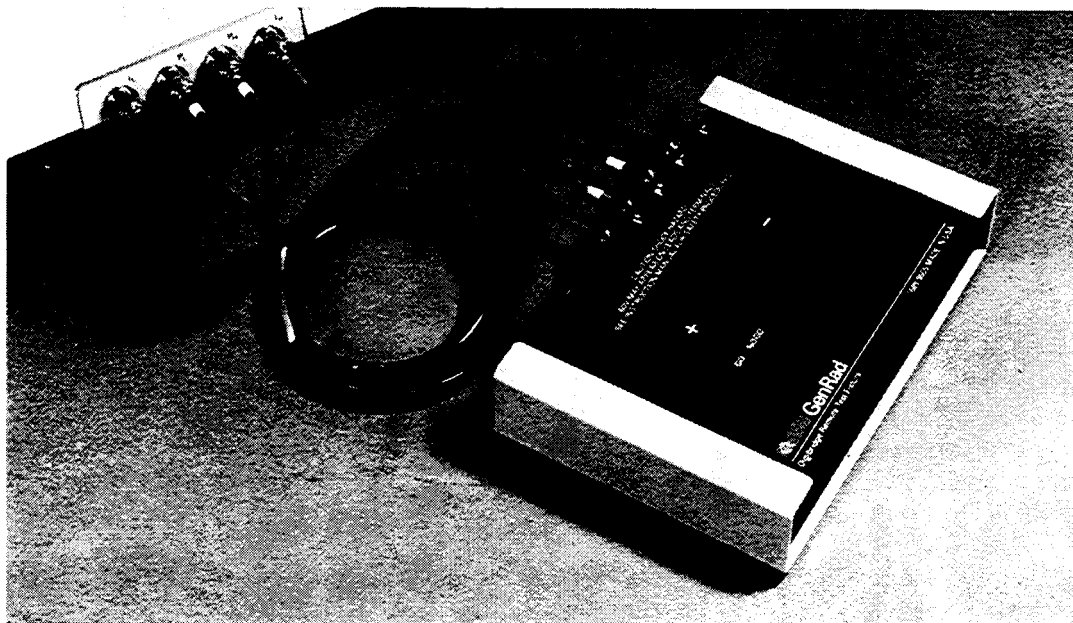

Figure 3-3. Remote test fixture (1689-9605), connected to a Digibridge tester.

**3.2.4 The 1689-9600 or -9605 Remote Test Fixture (with -9802 BNC Cable) Figure 3-3.**

Connection of the DUT at a remote test fixture normally requires:

- Remote Test Fixture 1689-9600, 1689-9605, or equivalent special fixture.
- BNC Cable Assembly 1689-9602 (cable, 4 BNC to 4 BNC)
- BNC Adaptor 1689-9601 (connects 1659 built-in test fixture into 4 BNC connectors)

This remote test fixture functions like the one supplied on the 1659 Digibridge. True "Kelvin" connections are made at the points of contact with the DUT leads. The recommended cable should be used (rather than any randomly chosen BNC patch cords) because the known cable parameters enable you to make corrections for best accuracy. Install the remote test fixture as follows.

- a. Remove any adaptors, cables, etc, if present, from the DUT port of the instrument.
- b. Connect the BNC adaptor (1689-9601) into the integral test fixture, with the BNC connectors facing forward. Lock the connection with the 2 captive thumb screws. (The screws must be seated to complete the ground connections.)
- c. Connect the BNC cable assembly 1689-9602 to the Digibridge and to the remote test fixture as indicated in Table 3-1. Note that red designates leads that may be "hot". (When bias is applied, they carry dc negative voltage with respect to ground.)

**Table 3-1**  
REMOTE TEST FIXTURE CONNECTIONS VIA BNC CABLE

Test-Circuit Function	Bias Polarity	BNC Connector at Digibridge	Color Code on 1689-9602 Cable	Connection at 1689-9600/-9605 Test Fixture *
IL (current, low)	+	Left	Black	I+, Left
PL (potential, low)	+	Left-center	Black/white	P+, Left-center
PH (potential, high)	-	Right-center	Red/white	P-, Right-center
IH (current, high)	-	Right	Red	I-, Right

\* Left and right are defined with the fixture oriented for reading the legend.

d. For the 1689-9605 remote test fixture -in order to activate the "Start" bar and the GO/NO-GO lights connect the 1689-2400 Remote Tester Cable (supplied with the fixture) as follows. Connect one end to the HANDLER INTERFACE connector behind the instrument. Connect the other end to a similar connector behind the fixture.

e. Before making measurements, be sure to repeat the zeroing procedure (open circuit and short circuit), as described in paragraph 3.1.3.

NOTE: User provided cables and/or remote test fixtures can be used, particularly if the DUT is to be handled automatically. (See paragraph 3.11 about handlers.) For notes on cable and fixture capacitance and zeroing, see paragraph 3.2.7, below.

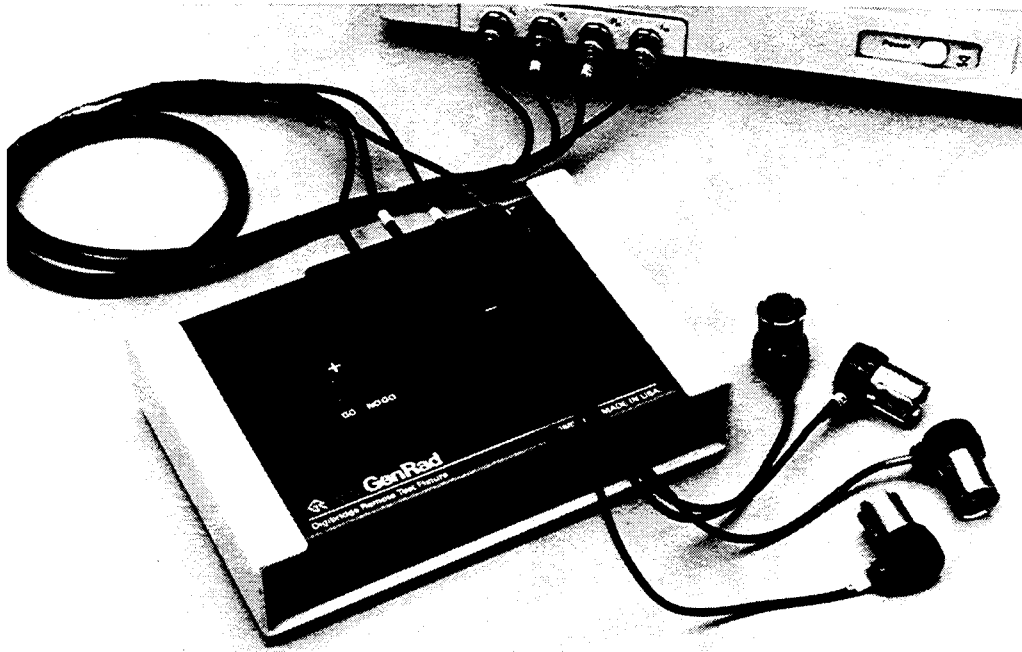

Figure 3-4. The type 874 extender cable is shown plugged into a Digibridge remote test fixture. Notice that the two thumb screws must be hand tightened for the guard connection (shields of cable).

### 3.2.5 The 1688-9600 Extender Cable ("Type 874" Connectors)

Figure 3-4.

The accessory extender cable 1688-9600 can be used to connect a DUT that is multiterminal, physically large, or otherwise unsuited for the built-in test fixture. This low-capacitance cable is used, for example, to connect type--874 equipped impedance standards or a special test fixture. The cable tips are type 874 coaxial connectors, which mate with a broad line of components and adaptors. Make connections as follows.

- a. Remove the adaptors, if present, from the Digibridge test fixture
- b. Plug the single-connector end of the extender cable into the test fixture so that its blades enter both slots and the cable lies away from the display panel (or away from the BNC connectors of the remote test fixture). Lock the connector with the two captive thumb screws.
- c. Using the type 874 connectors, connect to the DUT with careful attention to the following color code.

IL (current, low)	Black/black	Connect to first (+) main terminal of DUT.
PL (potential, low)	Black/white	Connect to first main terminal of DUT.
PH (potential, high)	Red/white	Connect to second (-) main terminal of DUT.
IH (current, high)	Red/red	Connect to second main terminal of DUT.
Guard (shield or gnd)	Outer contacts	Connect to shield or case of DUT, if any, <i>only</i> if isolated from main terminals.

Notice that the 2 cables with red must connect to the same end of the DUT, through a coaxial tee if the DUT is a 2-terminal or 3-terminal device; the 2 cables labeled with black, connect to the other end, similarly. Connection of guard, via the outer portion of the coaxial connector, should be to the shield or case of the DUT, *but NOT to either of the two main terminals.*

### 3.2.6 The 1657-9600 Extender Cable (Banana Plugs) and BNC Cable with Banana Plug Adaptors

#### *1657-9600 Extender Cable* (Recommended for 1659 Digibridge)

The accessory extender cable 1657-9600 is available to connect to DUTs that are multiterminal, physically large, or otherwise unsuited for the built-in test fixture. (Refer to table of accessories and options, paragraph 1A.) This cable is particularly convenient for connecting multiterminal components with binding posts that accommodate banana plugs.

- a. Remove the adaptors, if present, from the test fixture.
- b. Plug the single-connector end of the extender cable into the Digibridge test fixture so that its blades enter both slots and the cable lies away from the display panel. Lock the connector with the two captive thumb screws.
- c. Note the color coding of the five banana plugs. Be sure that the "low" terminals (both potential and current) connect to one end of the DUT and the "high" terminals to the other end. Connect guard to a shield if any, but not to either end of the DUT. Refer to the following tabulation.

IL (current, low)	Black	Connect to first (+) main terminal of DUT.
PL (potential, low)	Black/white	Connect to first main terminal of DUT.
PH (potential, high)	Red/white	Connect to second (-) main terminal of DUT.
IH (current, high)	Red	Connect to second main terminal of DUT.
Guard (shield or gnd)	Black/green	Connect to shield of DUT, if any, but <i>not</i> to either main terminal.

NOTE: The Kelvin junctions (IL & PL) and (PH & IH) can be made by using stackable banana plugs, for convenience -so that only one connection is sufficient at each main terminal of the DUT. Then, to obtain best results, it is very important to locate the banana-plug hardware in final position while zeroing (paragraph 3.1.3).

#### NOTE

Avoid contact between outer conductors of BNC-to-banana adaptors. (Measurements with high test frequency are liable to have errors that result from the changing mutual inductances between shields of cable conductors.)

### 3.2.7 The Effects of Cable and Fixture Capacitances

It is important to use very low-capacitance shielded wire for cables, not only for accuracy, but also to minimize resonance effects in the measurement of large inductance at high frequency.

*The Capacitances that are Most Liable to Affect Accuracy.* Any test fixture extension cable adds a bit of capacitance in parallel with the DUT (because shielding of the leads is imperfect) and more between each terminal and ground. The zeroing process (paragraph 3.1.3) will compensate fully for the capacitances between cables in any normal test setup.

However, capacitance between ground and the "low" connections at the DUT (C from ground to IL and C from ground to PL, in parallel, designated Csn) can affect measurement accuracy of very-high-impedance DUTs at high frequencies.

*Zeroing.* Be sure to repeat either the entire power-up procedure or at least the open-circuit and short-circuit zeroing procedure after any change in test fixtures or their cable connections.



Figure 3-5. 1689-9603 tweezers connected to a Digibridge, with BNC adaptor.

### 3.2.8 The 1689-9603 Tweezers

Figure 3-5.

The 1689-9603 tweezers combine the two functions:

1. Tweezers for handling chip components, up to 0.5 in. (12 mm) thick.
2. Test fixture for measuring these components, if their terminals are on opposite faces.

With these tweezers, you can conveniently pick up a tiny chip component, measure it, and put it in a bin (or decide what else to do with it), all in one operation.

Installation on the 1659 Digibridge requires BNC Adaptor 1689-9601. Install as follows:

- a. Remove any adaptors, cables, etc, if present, from the DUT port of the instrument.
- b. Plug the 1689-9601 BNC adaptor into the integral test fixture, with the BNC connectors facing forward. Lock the connection with the 2 captive thumb screws, which must be seated to complete the ground connection.
- c. Connect the BNC cables of the tweezer assembly to the Digibridge as indicated in Table 3-1. In this table, ignore the last column (about the remote test fixture). Note that red designates leads that may be "hot". (When bias is applied, they carry dc negative voltage with respect to ground.)

d. If dc bias is used (see paragraph 3.7), notice that the faces of the tweezers are labeled "+" and "-" to indicate bias polarity.

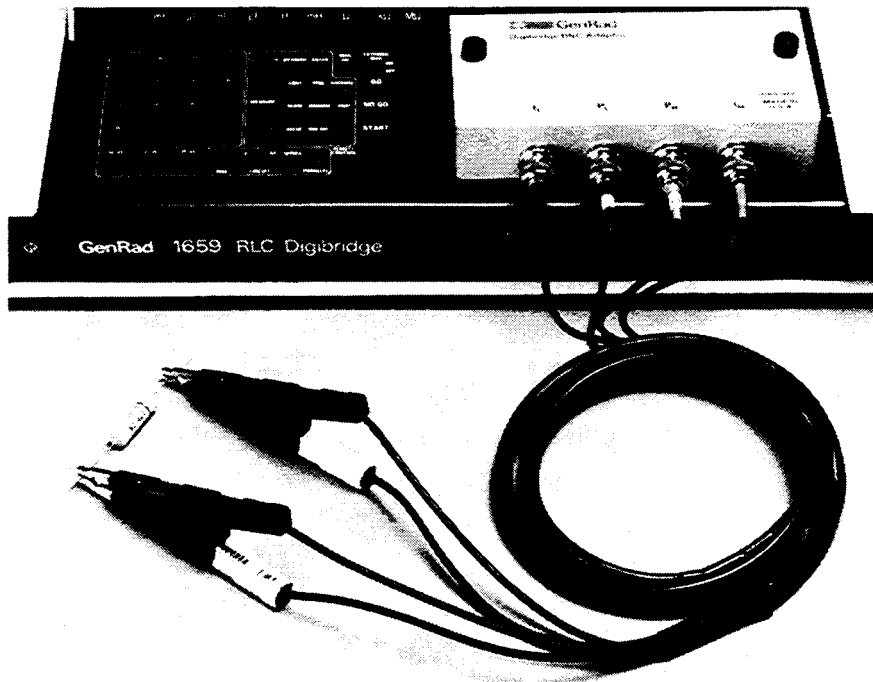

Figure 3-6. 1689-9606 Kelvin Clips connected to a Digibridge.

### 3.2.9 The 1689-9606 Kelvin Clip Cable

Figure 3-6.

The 1689-9606 Kelvin Clip Cable provides a means for easily making four terminal (Kelvin) connections to passive components. This cable is especially useful for testing low impedance devices or devices with large nonstandard terminations, such as electrolytic capacitors or inductors.

Installation the the 1659 Digibridge requires the 1689-9601 BNC Adaptor. Install Kelvin Clips as follows:

- a. Remove any adaptors, cables, etc., if present, from the DUT port of the instrument.
- b. Plug the 1689-9601 BNC Adaptor into the integral test fixture, with the BNC connectors facing forward. Lock the connection with the 2 captive thumb screws, which must be seated to complete the ground connection.
- c. Connect the BNC cables of the tweezer assembly to the Digibridge as indicated in Table 3-1. In this table, ignore the last column (about the remote test fixture). Note that red designates leads that may be "hot". (When bias is applied, they carry dc negative voltage with respect to ground.)

NOTE: Instructions supplied with the 1689-9606 may differ from Table 3-1. It is important to be aware that if DC BIAS is used, that it is a negative voltage and that it is applied to the **IH** lead from the instrument.



### 3.3 MEASUREMENT PARAMETERS, RESULTS DISPLAYS, AND OUTPUTS

#### 3.3.1 Parameters (R/Q, L/Q, C/D)

*Automatic Selection.* The Digibridge as powered up provides you with automatic selection of parameters (unless keyboard has been locked with a particular parameter selected).

This feature enables you to measure any passive component (without knowing whether it is essentially a resistor, inductor, or capacitor). It is provided at power-up and remains enabled as long as you do NOT select any particular parameter.

Automatic parameter selection can be disabled by pressing any of the three parameter keys: R/Q, L/Q, or C/D. Once disabled, this feature can be enabled again only on a power-up.

When selecting the parameter automatically, the Digibridge calculates Q: if  $|Q| < 0.125$ , R is selected; otherwise, for positive Q, L is selected; and for negative Q, 0 is selected. (The sign of Q is the same as the sign of the reactive component of impedance.)

*Manual Selection* To select the parameter to be measured:

- a. Press one of the 3 parameter keys:

[R/Q, L/Q, C/D].

- b. Use the [EQUIVALENT CIRCUIT] key to select SERIES or PARALLEL. Note: When you select SERIES equivalent circuit, the 3 parameter keys function as Rs/Q, Ls/Q, Cs/D (s for series). When you select PARALLEL equivalent circuit, the 3 parameter keys function as Rp/Q, Lp/Q, Cp/D (p for parallel).

Note: Equivalent circuits are discussed below, in paragraph 3.3.2.

For an inductor select L/Q; for a capacitor, C/D; for a resistor, R/Q. There will be an immediate confirmation on the display panel, where appropriate unit indicators will be lit. (However, do not attempt to select the unit multiplier.) The Digibridge will automatically switch to the appropriate multiplier -from mF to pF for example -, unless RANGE IS HELD, when it makes a measurement. *The result will be displayed in terms of the parameters and equivalent circuit that you select, even if the DUT has the opposite kind of reactance; see below.*

Note: Observing the results displays can be helpful in deciding whether you have made the best parameter selection. (See below.) Displays are discussed further in paragraph 3.3.3.

*NEGATIVE RLC.* If RLO is negative with an L or C value displayed, the DUT reactance is opposite to the selected parameter. As a rule, you should change parameter (usually select L instead of C or vice versa) so that a positive L or C value display can be obtained. However, the displayed negative value of L or C is mathematically correct and (without the minus sign) is in fact the value that will resonate with the DUT at the test frequency. Notice that the appearance of a device can be misleading. (For example, an inductor is capacitive if test frequency is above resonance; or a component part can be mislabeled or unlabeled.)

When the display is VALUE or BIN No., avoid incorrect choice of parameter by watching for a negative sign on the RLC display. A negative sign (-) indicates that the principal parameter (L or C) was selected incorrectly. Try the opposite choice.

For more information about both the negative RLC and the negative QD, see paragraph 3.3.3.

### 3.3.2 Equivalent Circuits -Series, Parallel

The results of R, L, or C measurements of many components depend on which of two equivalent circuits is chosen to represent it -series or parallel.

The more nearly "pure" the resistance or reactance, the more nearly identical are the "series" and "parallel" values of the principal parameter. However, if D is high or Q low, Cs differs substantially from Cp and Ls differs substantially from Lp; and these values are frequency dependent. Usually several measurements at frequencies near the desired evaluation will reveal that either series measurements are less frequency dependent than parallel, or the converse. The equivalent circuit that is less frequency dependent is the better model of the actual device.

We first give general rules for selection of measurement parameters, then some of the theory.

*Making the Selection.* The power-up selection is "series", confirmed by the SERIES indicator being lit, on the keyboard. To change the selection, press the [EQUIVALENT CIRCUIT] key.

*Specifications.* The manufacturer or principal user of the DUT probably specifies how to measure it. (Usually "series" is specified.) Refer also to the applicable MIL or EIA specifications. Select "parallel" or "series" and the test frequency according to the applicable specifications. If there are none known, be sure to specify with your results whether they are "parallel" or "series" and what the measurement frequency was.

*Suggested Test Conditions.*

Capacitors less than 10 pF: Parallel, 10 kHz.  
Capacitors from 10 to 400 pF: Series or Parallel, 10 kHz.  
Capacitors from 400pF to 1 uF: Series, 1 kHz.  
Capacitors greater than 1 uF: Series, 100 or 120 Hz.

Unless otherwise specified or for special reasons, always select "series" for capacitors and inductors. This has traditionally been standard practice. For very small capacitance, select a higher measurement frequency for best accuracy. (Refer to paragraph 3.6.) Conversely, for very large capacitance, select a lower measurement frequency for best accuracy.

Inductors less than 1 mH: Series, 10 kHz.  
Inductors from 1 mH to 1 H: Series, 1 kHz.  
Inductors greater than 1 H: Series, 100 or 120 Hz.

Select "series" as explained above. For very small inductance, select a higher measurement frequency for best accuracy. Conversely, for very large inductance, select a lower measurement frequency for best accuracy .

*Resistors, below about 1 kilohm: Series, 1 kHz.* Usually the specifications call for dc resistance, so select a low test frequency to minimize ac effects. Select "series" because the reactive component most likely to be present in a low resistance resistor is series inductance, which has no effect on the measurement of series R.

*Larger Resistors, greater than 1 kilohm: Parallel, 100 or 120 Hz.* As explained above, select a low test frequency. Select "parallel" because the reactive component most likely to be present in a high-resistance resistor is shunt capacitance, which has no effect on the measurement of parallel R. If the Q is less than 0.1, the measured Rp is probably very close to the dc resistance.

*Theory -Series and Parallel Parameters.* See Figure 3-7. An impedance that is neither pure reactance nor a pure resistance can be represented at any specific frequency by either a series or a parallel combination of resistance and reactance. The values of resistance and reactance used in the equivalent circuit depend on whether a series or parallel combination is used. Keeping this concept in mind will be valuable in operation of the instrument and interpreting its measurements.

The equivalent circuits are shown in Figure 3-7, together with useful equations relating them. Notice that the Digibridge measures the equivalent series components  $R_s$ ,  $L_s$ , or  $C_s$ , if you select SERIES EQUIVALENT CIRCUIT. It measures the parallel equivalent components  $R_p$ ,  $L_p$ , or  $C_p$  if you select PARALLEL.  $D$  and  $Q$  have the same value regardless whether series or parallel equivalent circuit is calculated.

**Resistance and Inductance**

$$X = \omega L$$

$$Z = R_s + j\omega L_s \quad Z = \frac{j\omega L_p R_p}{R_p + j\omega L_p} \quad Z = \frac{R_p + jQ^2\omega L_p}{R_p + j\omega L_p}$$

$$Q = \frac{1}{D} \quad Q = \frac{\omega L_s}{R_s} \quad Q = \frac{R_p}{\omega L_p}$$

$$L_s = \frac{Q^2}{1+Q^2} L_p \quad L_s = \frac{1}{1+D^2} L_p$$

$$L_p = \frac{1+Q^2}{Q^2} L_s \quad L_p = (1+D^2) L_s$$

$$R_s = \frac{\omega L_s}{Q} \quad R_p = Q\omega L_p \quad R_p = \frac{1}{G_p}$$

$$B_p = -\frac{1}{\omega L_p} \quad y = G_p - j\frac{1}{\omega L_p}$$

**Resistance and Capacitance**

$$X_s = -\frac{1}{\omega C_s}$$

$$Z = R_s - j\frac{1}{\omega C_s} \quad Z = \frac{R_p}{1 + j\omega R_p C_p} \quad Z = \frac{D^2 R_p + 1/(j\omega C_p)}{1 + D^2}$$

$$D = \frac{1}{Q} \quad D = \omega R_s C_s \quad D = \frac{1}{\omega R_p C_p}$$

$$C_s = (1+D^2) C_p \quad C_p = \frac{1}{1+D^2} C_s$$

$$R_s = \frac{D^2}{1+D^2} R_p \quad R_p = \frac{1+D^2}{D^2} R_s$$

$$R_s = \frac{D}{\omega C_s} \quad R_p = \frac{1}{\omega C_p D} \quad R_p = \frac{1}{G_p}$$

$$B_p = \omega C_p \quad y = G_p + j\omega C_p$$

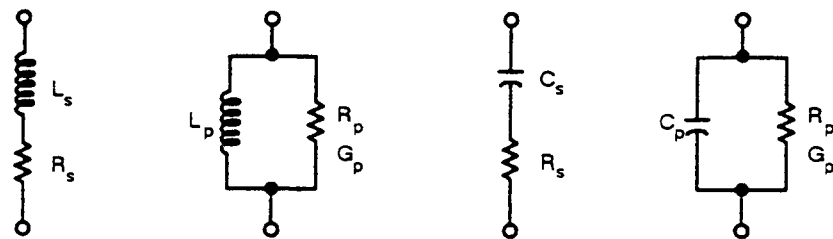

Figure 3-7. Equivalent circuits and mathematical relationships for lossy inductors and capacitors.

*ESR for Capacitor.* The total loss of a capacitor can be expressed in several ways, including  $D$  and "ESR", which stands for "equivalent series resistance" and which is designated " $R_s$ " in the preceding paragraph. To obtain ESR, be sure that the SERIES indicator is lit; and push the [R/Q] key.

"Equivalent series resistance" is typically much larger than the actual "ohmic" series resistance of the wire leads and foils that are physically in series with the heart of a capacitor, because ESR includes also the effect of dielectric loss. ESR is related to  $D$  by the formula:

**3-14 OPERATION**

$$ESR = R_s = D/\omega C_s$$

(where  $\omega$  represents "omega" =  $2 \pi \times$  frequency).

*Parallel Equivalent Circuits for Inductors.* Even though it is customary to measure series inductance of inductors, there are situations in which the parallel equivalent circuit better represents the physical device. For small "air-core" inductors, the significant loss mechanism is usually "ohmic" or "copper loss" in the wire; and the series circuit is appropriate.

However, if there is an iron core, the significant loss mechanism may be "core loss" (caused by eddy currents and hysteresis); and the parallel equivalent circuit is appropriate, being a better model of the inductor. Whether this is true at any particular frequency should be determined by an understanding of the DUT, but probably it is so if the following is true: that measurements of  $L_p$  at two frequencies near the frequency of interest differ from each other less than do measurements of  $L_s$  at the same two frequencies.

### 3.3.3 Results Displayed

#### PRINCIPAL MEASUREMENT RESULTS

The principal Digibridge measurement will be presented on the left (RLC) part of the display panel in one of two ways; VALUE or BIN No., (only one way for any single measurement).

*VALUE, Selected by the (DISPLAY) Key.* This measurement provides two displays: the principal one is RLC (resistance, inductance, or capacitance) and the secondary one is QD (quality factor with R or L, either dissipation factor with C). The VALUE selection is the power-up default and one of the selections of the [DISPLAY] key.

Read the measurement on the main displays. The RLC display is the principal measurement, complete with decimal point and units which are indicated by the light spot in the lower part of the display panel. The light spot above the display identifies the measurement parameter (RLC or BIN NO.). The QD display is Q if the selected parameter is R/Q or L/Q; or D for C/D. The light spot above the display also identifies the measurement parameter (Q or D). Leading zeros before the decimal point are automatically eliminated in most cases by positioning of the decimal point. Otherwise, such zeroes are blanked out.

*NEGATIVE RLC.* If the RLC is negative with an L or C value displayed (or with parameter selection L or C and BIN NO. displayed), the DUT reactance is opposite to the selected parameter. Generally, you should change parameter (usually select L instead of C or vice versa) so that a positive L or C value display can be obtained. See paragraph 3.3.1.

*Bin No.* Selected by using the [DISPLAY] key. When measurement is completed, the bin assignment will be shown on the left (RLC) display only, as a one-digit number, with the following significance:

- 0 = No-Go because of the secondary (QD) limit
- 1 = Go, bin 1
- 2 = Go, bin 2
- ...Go, bin 3, 4, 5, 6, 7, or 8, as indicated.
- 9 = No-go by default (suits no other bin).

#### SECONDARY MEASUREMENT RESULTS

The secondary Digibridge measurement will be presented on the right (QD) display panel, for each measurement if the DISPLAY selection is VALUE. There is no secondary display if the selection is BIN NO.

*NEGATIVE QD.* A negative QD has the following meanings.

Parameter Selection	+ QD	- QD
R/Q	DUT is inductive	DUT is capacitive
L/Q or C/D	Q, D is positive	Q, D is negative (see below)

If the secondary measurement is negative -Q, D as calculated by the Digibridge when selected parameter is L/Q, O/D - then there are two likely possibilities. If the Q or D value (whichever is being displayed) is very small, a small (acceptable) calibration and/or measurement error can lead to a negative result. (It should of course fall within the specified accuracy of the instrument.) Measurement error can be reduced by choice of measurement conditions, averaging, etc. Another possibility is that the DUT (as seen by the Digibridge) really does have a negative loss factor. This situation might occur when you are measuring certain kinds of multiterminal networks or active devices.

**NOTE**

Improper connection of extender cables can cause a false indication of negative QD.

**GO/NO-GO INDICATORS**

If comparison is enabled, by a non-zero entry for "nominal value", and limits in at least one bin, a GO or NO-GO indication is provided at the keyboard, for every measurement. If you are using the 1689-9605 remote test fixture, a GO/NO-GO indication appears there also. (The display selection can be whatever you choose.) GO means the measurement falls in bin 1 through 8; NO-GO means bin 0 or 9.

**Table 3-2  
UNITS AND MULTIPLIERS FOR EACH RANGE**

Parameter	Freq: 100Hz, 120Hz, 1kHz				10kHz			
	Range: 1	2	3	4	1	2	3	4
R	K *	K *	ohm	ohm	K *	K *	ohm	ohm
L	H	H	mH	mH	H	mH	mH	mH
C/D	pF	nF	nF	uF **	pF	nF	nF	nF

\* Units can be in Mohms for high values on this range. When ranging up the units, will change from Kohms to Mohms at 2000 Kohms. When ranging down, the units will change from Mohms to Kohms at .5 Mohms.  
 \*\* Units can be in mF for high values on this range. When ranging up the units will change from uF to mF at 2000 uF. When ranging down, the units will change from mF to uF at .5 mF.

**3.3.4 Units, Multipliers**

Units of R, L, and C are determined entirely by your selection of parameter. Units multipliers are fixed by parameter, range, and frequency. See Table 3-2.

Units of D and Q are dimensionless and are expressed as a decimal ratio, without multiplier. To obtain D or Q in percent, from the regular display, move the decimal point two places to the right. For example, a regular display of D = .0045 is equivalent to 0.45%

*Decimal Point Position.* The decimal point is automatically positioned for maximum resolution (i.e., so that the first significant digit or the first zero after the decimal point is in the first position in the display) with a few exceptions, as listed below. Of course, displays on low underrange or low extension of a held range may have a number of necessary zeros to the right of the decimal point (and therefore reduced number of significant digits compared to the display area) because units and multipliers are fixed on any range. The above-mentioned exception is: Hysteresis is provided to reduce flickering, as explained below.

If the first digit of the measurement is 9, the decimal point for any measured-value display is left unchanged from its previous position, provided that so doing places that 9 in either the first or second position in the display area. (Notice that a number like 09XXX has resolution almost as fine as a number like 10XXX.)

For example, if the measured value is 99.985 nF, the display is a full 5 digits if the previous measured-value display was 12.345, 99.984, or 99.999; but the display is rounded off to 099.98 nF if the previous measured-value display was 100.02 or 1234.5 nF. Hysteresis is provided on both measured-value displays (RLC and QD).

*Blanks in Measured- Value Displays.* If a measurement exceeds the capability of the display (99999 for RLC display, 9999 for QD), the display is blank. If a measurement is less than 1 right-hand digit, the display is all zeros. If any leading zero before the decimal point must occupy a position in the display, that zero is blanked out.

## **3.4 PRINCIPAL TEST CONDITIONS**

### **3.4.1 Test Frequency**

Power-up frequency is 1 kHz, unless the keyboard has been locked with some other choice. There are 3 other frequencies, available (100 Hz, 120 Hz, and 10 kHz).

*Selection.* To change the test frequency, simply press the [SHIFT] key and then the [FREQUENCY] key. Repeat keying of the [SHIFT] [FREQUENCY] keys will change the frequency.

*Indication.* The light-spot LED on the right of the display panel will indicate the test frequency selected.

### **3.4.2 Test Voltage**

The test voltage is always 0.3 volt rms on the 1659 Digibridge.

The actual voltage across the DUT is never more than the source voltage, and depends on the DUT impedance and the source resistance of the Digibridge, for the range in use. The DUT voltage is close to the source voltage at the high-impedance end of each measurement range and lower at the low-impedance end. Normally, the smallest voltage across the DUT (if its impedance is 6.25 ohms or more) will be 20% of the source voltage; this is the case for resistors measured at the low end of each range. Refer to Table 3-3 for details.

For example, what is the voltage across the DUT if it is a 1- $\mu$ F capacitor. Assume the test frequency is 1 kHz, at a test voltage of 0.3 V and the RANGE HELD indicator is NOT lit. The Digibridge will measure on range 3, with 0.3 V behind source resistance of 400 ohms. The DUT reactance is 47.7 ohms and the voltage across it is 111 mV.

**Table 3-3  
AUTORANGING MEASUREMENT RANGES AND SOURCE RESISTANCES**

Range	Source *	Principal Measured Parameter **		
	Resistance	Resistance	Capacitance	Inductance
1	97.4 kohms	max 99999 M	min .00001 pF	max 99999 H
		mid 102 K	mid 1600 pF/f	mid 16 H/f
		min 25.6 K	max 6400 pF/f	min 4.1 H/f
2	6.4 kohms	max 25.6 K	min 6.4 nF/f	max 4100 mH/f
		mid 6.4 K	mid 25.3 nF/f	mid 1025 mH/f
		min 1.6 K	max 100. nF/f	min 256 mH/f
3	400 ohms	max 1600 ohms	min 100 nF/f	max 256 mH/f
		mid 400 ohms	mid 400 nF/f	mid 64 mH/f
		min 100 ohms	max 1600 nF/f	min 16 mH/f
4	25 ohms	max 100 ohms	min 1.6 uF/f	max 16 mH/f
		mid 25 ohms	mid 6.4 uF/f	mid 4 mH/f
		min .00001 ohm	max 99999 mF	min .00001 mH

\* Selection of EXTERNAL BIAS makes  $R_s = 25$  ohms on all ranges; see paragraph 3.7.2. \*\* "K" is kilohms; "M" is Megohms; "r" is equal to the test frequency in kHz.

### 3.4.3 Other Conditions

Other test conditions are described in other parts of this manual. Averaging (10 measurements averaged) paragraph 3.6.2. Bias applied to the DUT (if it is a capacitor) -refer to paragraph 3.7.

## 3.5 MEASUREMENT TIME AND MEASUREMENT RANGES

### 3.5.1 General

Selection of MEASURE RATE (SLOW, MEDIUM, and FAST) obviously relates to measurement time, providing the user with an easily made choice. (The slower rates provide greater accuracy.)

In this paragraph, the many items that affect measurement time are explained. The measurement time (required to complete a measurement and display the results) depends not only on the selected measure rate, but also on the test conditions, choice of display, whether data is being sent out to other devices, etc. The best combination of conditions for any particular job should be selected recognizing their effects on speed and accuracy.

The minimum measurement time is about 125 ms (8 meas/sec). The corresponding conditions are: measure rate = fast, display selection = bin no., and no data output via IEEE-488 bus.

### 3.5.2 Measure Rate Selection at Keyboard

Choose one of 3 basic measurement rates with the [MEASURE RATE] key: SLOW, MEDIUM, or FAST. The measurement rates (continuous or triggered) are respectively about 2, 4, and 8 measurements per second, if the other test conditions are left at normal power-up defaults.

The tradeoff is speed vs. accuracy. The Digibridge will make a more precise and accurate measurement at a slower rate. For the above conditions, in very simplified terms, the basic accuracy is 0.1%, and the tradeoff is as follows:

SLOW rate, 2 measurement per second, 0.1% accuracy (or better);  
MEDIUM rate, 4 measurements per second, 0.2% accuracy (or better);  
FAST rate, 8 measurements per second, 0.5% accuracy (or better).

For details on accuracy, refer to the specifications.

### 3.5.3 Measure Mode and Display Selection, Effects on Measurement Time

*Measure Mode TRIGGERED.* Selection of TRIGGERED results in a measurement rate the same as CONTINUOUS.

*Measure Mode CONTINUOUS.* Selection of CONTINUOUS results in a measurement rate discussed in paragraph 3.5.2 above. CONTINUOUS is also the power-up default mode. Notice that in continuous mode, the measurement being made when the DUT is connected to the Digibridge is erroneous.

*Display Selection.* The selection of BIN NO. display cuts 6 to 10 ms from the measurement time, compared to the other choice of display. Therefore, the BIN NO. choice is recommended for use with an automatic parts handler, if maximum throughput is desired and there is no need for the operator to observe values.

More information about operation with a parts handler is given in paragraph 3.11.

### 3.5.4 Ranges, Range Changing, and Holding a Range to Save Time

#### RANGES and RANGE CHANGING

Descriptions of ranges, range extensions, and decimal point control are explained below.

*Basic Ranges.* The 4 basic ranges are numbered 1, 2, 3, 4, in order of decreasing impedance. Each basic range is approximately a factor of 16 wide. Refer to paragraph 3.4.2 for a table of ranges.

The word "upper" as used below refers to increasing measured value (which is the direction of increasing range number only if the principal measured parameter is capacitance). Similarly, the word "lower" as used below refers to decreasing measured value (which is the direction of decreasing range number only if the principal measured parameter is capacitance).

*Extensions.* Each of the 4 ranges goes beyond its basic range, with both upper and lower range extensions (also called overrange and underrange). Most of these extensions are seldom used because they overlap basic portions of other ranges and the Digibridge will automatically select the basic range unless you have selected "hold range" (see RANGE HELD indicator). Measurement units and multipliers in any range extension are the same as in the basic range. The fact that range definition depends on frequency causes a considerable variation in the width of range extensions. The lower limit is generally .00001, with all-zeros next; the upper limit is 99999,



with all blanks next. Blanks in the measurement display are discussed below. In general, for any measurement within the specifications of the Digibridge, if a measurement can be displayed, it will be.

The only range extensions that are valid with autoranging are low underrange and high overrange, explained below.

*Low Underrange.* The "low" extension of the low range goes down to 1 count, with reduced accuracy. The smallest "1-count" increment in the display is the minimum measured value, given in the specifications in the front of this manual. Any measurement smaller than 1 count is displayed as all zeros.

*High Overrange.* The "high" extension of the high range goes up to the maximum display (all 9's, with the decimal point at the right), and finally to blank, with reduced accuracy. The high overrange is used for the very large values of RLC that exceed the basic high range.

*Autoranging.* Autoranging is normal; it is inhibited only if you select RANGE HELD. There is a slight hysteresis in the changeover from range to range to eliminate a possible cause of display flickering.

*Time Required to Change Range.* The Digibridge must almost complete a measurement cycle in the previously established range before starting measurement in the range to which it changes. The Digibridge completes the data acquisition and a large part of the calculation process before "deciding" whether the present range is best for the measured value. Thus, measuring a lot of components that straddle a range boundary requires almost double the regular measurement time for every DUT that is on the opposite side of the boundary from its predecessor. (Note: if the Digibridge starts in range 1 to measure in range 4, four almost complete measurement cycles are required before the desired result appears.) Therefore (at least in some measurement situations), maximum measurement speed requires range holding.

## RANGE HOLDING

*Why Hold a Range?* The most important use of the range holding capability is to avoid range changes when the component is removed from the fixture when in the CONTINUOUS mode. With no component connected, the instrument will autorange to range 1. Thus, if range 1 is not selected when the component is in place, considerable time is lost by unnecessary autoranging. Another use of the range hold occurs when measuring components of the same nominal value whose actual values spread across the boundary between two ranges. If allowed to autorange, the units and decimal point may change with range which may be confusing to the operator. There are other uses for holding a range, such as obtaining the correct bias current or getting better guard capability. When a range is held that is not the range that autoranging would select, the accuracy may be sacrificed.

To inhibit autoranging, select the "range held" mode (RANGE HELD indicator lit) as described below *-three methods.*

*To Hold Present Range.* If the present range (as indicated by the measurement display) is desired, press:

[HOLD RANGE]      to light the RANGE HELD indicator.

(To return to the normal autoranging feature, press the same key again, making the RANGE HELD indicator **unlit.**)

*To Hold the Range of a Sample DUT.* One way to get into the desired range is to measure a DUT known to be in that range, thus:

Measure the DUT as usual.  
 Verify that the desired range is confirmed by the measurement display.  
 Press: [HOLD RANGE] to light the RANGE HELD indicator.

(To return to the normal autoranging feature, press the same key again, making the RANGE HELD indicator unlit.)

*To Hold the Range selected by Use of a Parameter Key.* Another way to get into the desired range is to use a parameter key, thus:

Select ENTER function with the [FUNCTION] key. Press the appropriate parameter key (such as C/D) repeatedly, watching the units indicators. The range advances with each repetition, enabling you to determine the present range by the pattern of changes. Notice that there is *not* always a change of unit multiplier with each range change. (Refer to the table in paragraph 3.3.4.)

The ranges will change in a 4 3 2 1 4 ...sequence.

Press: [HOLD RANGE] to light the RANGE HELD indicator. (To return to the normal autoranging feature, press the same key again, making the RANGE HELD indicator unlit.)

### 3.5.5 Time Required for Obtaining Average

Accuracy can be enhanced, at the cost of increased measurement time, by averaging. The time considerations and a brief instruction for selecting this method is given here.

*Averaging.* The measurement time is multiplied by the number of measurements. An average of 10 measurements is possible with the 1659 Digibridge. To select the Digibridge for an average of 10 measurements, press:

[MODE] key to select AVERAGE

### 3.5.6 Time Required if IEEE-488 Output is Enabled

**Figure 3-8.**

If data output is enabled, via IEEE-488 bus, additional time -about 2 ms to 12 ms is required per measurement. This time requirement depends on the selected display and what data is being sent out, approximately as follows. (Refer to explanation of operation with the IEEE-488 interface, paragraph 3.11.)

Output data:	Regular Output Data Format						CBF *	
	BIN	RLC	QD	RLC,QD	BIN,RLC	BIN,QD		BIN,RLC,QD
Display = BIN NO.	2	6	8	10	10	10	12 ms	(any)
Display = other	2	2	2	4	4	4	6 ms	< 2 ms

\* **Compacted Binary Format.** If the compacted binary format is selected, data output requires less than 2 ms.

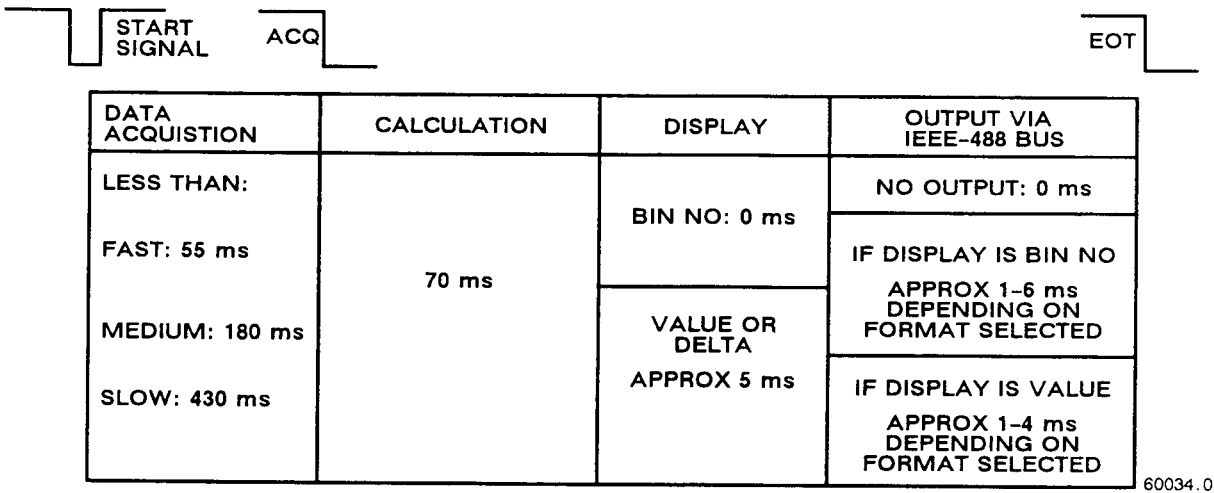

60034.0

Figure 3-8. Summary of the components of measurement time.

Refer to Figure 3-8 for a summary of the segments of measurement time used by the 1659 Digibridge and an indication of how the time per measurement depends on measurement conditions and system selections. The START signal can be received via START button, IEEE-488 bus, or handler interface. The ACQ (otherwise known as ACQ OVER) and EOT signals are sent via the handler interface.

### 3.6 ACCURACY, THE LIMITS OF ERRORS

#### 3.6.1 General

Refer to the Specifications, at the front of this manual. The specifications apply at an ambient temperature of 23 degrees C (unless recalibration has been done at some other temperature), in low humidity, if the OPEN and SHORT zeroing procedures have been executed properly (paragraph 3.1). These specifications are valid when autoranging is used or the optimum range is set and held. When a non-optimum range is set and held, the accuracy may decrease (see paragraph 3.6.4).

Typical accuracy is described below, for convenience in obtaining a birds-eye view of the way it relates to the principal test conditions.

Refinement of the zeroing procedure to enhance accuracy for certain kinds of measurements is described in paragraph 3.6.3.

### 3-22 OPERATION

### 3.6.2 Averaging to Improve Accuracy

The accuracy of measuring each DUT can be enhanced automatically by the Digibridge if you program it to make several measurements and average them before reporting the final result. Thus, errors due to electrical noise and other effects that are just as likely to make the measurement too high as too low are largely canceled. (This is true regardless of the display selection, VALUE or BIN NO.). Of course, the time required to complete a measurement with averaging set to 10 is 10 times as long as the time for a single measurement.

An average of 10 measurements is possible with the 1659 Digibridge. To select the Digibridge for an average of 10 measurements, press:

[MODE] key to select AVERAGE..

To inhibit averaging, press:

[MODE] key to select CONTINUOUS.

This is the default situation (no averaging).

When AVERAGE is selected, the display is repeatedly updated to be the running average, until the 10 measurements have been made; then the final average remains displayed until the next START command.

### 3.6.3 Accuracy Enhancement for Large or Small Impedances at Particular Frequencies

*Regular Zeroing at Test Frequency.* When measuring very large or small values of impedance, the Digibridge will provide much better accuracy than the specifications, *if* the OPEN and SHORT zeroing procedure has been recently repeated with test frequency set to the actual test condition.

NOTES. Even better accuracy is possible if several measurements are averaged. See paragraph 3.6.2, above.

### 3.6.4 Accuracy When Holding a Non-Optimum Range.

The accuracy specifications are valid when the optimum range is used for any given impedance value. The optimum range is selected by the autoranging capability. If some other range is selected and held by the operator, the specified accuracy will be poorer. This accuracy may be calculated by multiplying the Extreme Range Terms in the accuracy specifications by the factors given in Table 3-4.

**Table 3-4**  
**EXTREME RANGE TERM MULTIPLYING FACTORS**

Terms	Range 1	Range 2	Range 3	Range 4
-----				
--- Low End Terms ---				
R and L	5000	300	20	1
C	1	20	300	5000
--- High End Terms ---				
R and L	1	20	300	5000
C	5000	300	20	1

### 3.7 BIAS FOR THE DUT

#### NOTE

Keep the EXTERNAL BIAS switch OFF and the BIAS ON indicator unlit, for all measurements of inductors and resistors, and also for capacitors unless they are to be measured with dc bias applied.

#### 3.7.1 Internal Bias

To measure capacitors with the internally available 2-volt dc bias voltage applied, use the following procedure. (The FUNCTION should be :MEASURE.

a. Press [SHIFT] [INT BIAS] keys so that the BIAS ON indicator is lit. NOTE: This indication, for internal bias, is somewhat dimmer than the other keyboard indicators.

b. Observe correct polarity when inserting DUT into test fixture. Bias POSITIVE polarity is at the LEFT ("low" terminals) of the 1659 Digibridge built-in test fixture. Bias NEGATIVE polarity is at the RIGHT.

c. For each DUT, in the CONTINUOUS or TRIGGERED measure mode, disregard the first displayed result and read the second. Notice enough of the results to verify that the DUT has stabilized. Use the stable result.

NOTE: There are two effects to be aware of in watching for stabilization of the DUT: voltage and capacitance. Besides charging to a "final" voltage, there is also the stabilization of capacitance value itself. For example, some aluminum electrolytic capacitors respond slowly to a change in applied voltage, therefore the DUT capacitance can be settling long after the voltage is essentially stable.

d. Remove internal bias by pressing the [SHIFT] [INT BIAS] keys, so that the BIAS ON indicator is NOT lit.

#### NOTE

The BIAS ON indicator serves to indicate whether internal bias is connected or disconnected *only if the EXTERNAL BIAS is switched OFF.* (See below for external bias.)

Notice that repeating the same keyboard sequence will cyclically enable and disable internal bias. For best results, after removing bias and before making further measurements, allow at least 2 seconds for internal circuit discharge and settling.

#### 3.7.2 External Bias

If bias is required at some other voltage than the 2-V internal bias, use external bias as described below. Also:

Be sure that the voltage is never more than 60 V, max.

A current limiting voltage supply is recommended; set the limit at 200 mA, max.

Be sure that the bias supply is floating; DO NOT connect either lead to ground.

Generally the external circuit must include switching for both application of bias after each DUT is in the test fixture and discharge before the DUT is removed.

A well-filtered supply is recommended. Bias-supply hum can affect some measurements.

*Setup Procedure.*

- a. Connect the external bias voltage supply and switching circuit, using the 1658-2450 cable, supplied, via the rear-panel EXTERNAL BIAS connector. Observe polarity marking on the rear panel; connect the supply accordingly.
- b. Set the external supply to limit current ( $\ll 200$  mA).
- c. Set the external bias supply to the desired voltage ( $\ll 60$  V).
- d. If the Digibridge power is off, switch its POWER ON and wait for completion of the self-check routine before the next step.
- e. Switch the EXTERNAL BIAS ON (switch is at right of keyboard) and verify that the BIAS ON indicator is lit -see below. (If polarity is inverted, the indicator will not be lit as brightly as normal.) If the bias cable fuse must be replaced, use a 200 mA fast-acting fuse.
- f. Switch the bias off using an external switch, so that the DUT can be inserted before bias is applied to it. Refer to the Operating Procedure below.

NOTE

The BIAS ON indicator serves to indicate *that the EXTERNAL BIAS is switched ON, NOT NECESSARILY the presence of external bias.* See below.

*Indicator.* When the EXTERNAL BIAS switch is ON, the BIAS ON indicator shines as long as the Digibridge POWER is ON. (The indicator brightness depends somewhat on the external bias voltage.) Also, when the EXTERNAL BIAS switch is ON, but the POWER is switched OFF, this indicator is lit by external bias voltages above about 3 V.

*Effect on Power-Up.* Be sure that the EXTERNAL BIAS switch is OFF before you switch the Digibridge POWER ON. This is generally necessary to permit the power-up self checks to pass.

*Protection.* The Digibridge is internally protected from damage from charged capacitors with stored energy up to 1 joule at any voltage up to 60 V.

CAUTION

If your test procedure includes charging capacitors to higher energy or higher voltage before or during connection to the Digibridge, EXTERNAL PRECAUTIONS MUST BE TAKEN TO PROTECT THE INSTRUMENT.

NOTE

When EXTERNAL BIAS IS selected, the source resistance ( $R_s$ ) is 25  $\Omega$  for all ranges; otherwise, see Table 3-3.

### *Operating Procedure.*

a. Select MEASURE function.

b. Observe correct polarity when inserting DUT into test fixture. Bias POSITIVE polarity is at the LEFT ("low" terminals) of the 1659 Digibridge built-in test fixture. Bias NEGATIVE polarity is at the RIGHT.

c. Use the external switches (user supplied) to remove bias from the test fixture, apply bias after the DUT is in place, remove bias after measurement, and short the DUT before its removal. A routine like this is generally recommended.

However, for occasional (non-production) measurements, if the capacitances being measured are less than 200 uF and the bias voltage less than 30 V, an optional procedure is to leave the external bias circuitry "on" during measurements and to use the Digibridge EXTERNAL BIAS switch to apply bias to the DUT (ON) and to remove it and discharge the DUT (OFF).

d. For each DUT, in the CONTINUOUS or TRIGGERED measure mode, disregard the first displayed result and read the second. Notice enough of the subsequent results to verify that the DUT has stabilized. Use the stable result.

NOTE: There are two effects to be aware of in watching for stabilization of the DUT: voltage and capacitance. Besides charging to a "final" voltage, there is also the stabilization of capacitance value itself. For example, some aluminum electrolytic capacitors respond slowly to a change in applied voltage, therefore the DUT capacitance can be settling long after the voltage is essentially stable.

e. After biased measurements are completed, remove all bias by sliding the EXTERNAL BIAS switch OFF and if necessary pressing the [SHIFT] [INT BIAS] keys, so that the BIAS ON indicator is NOT lit.

## **3.8 BIN SORTING AND GO/NO-GO RESULTS**

### **3.8.1 Introduction to Binning (Sorting Based on Limit Comparisons)**

If a group of similar DUTs are to be measured, it is often convenient to use the limit-comparison capability of the Digibridge to categorize the parts. This can be done *in lieu of* or *in addition to* recording the measured value of each part. For example, the instrument can be used to sort a group of nominally 2.2-uF capacitors into bins of 2%,5%, 10%,20%, lossy rejects, and other rejects. Or it can assign DUTs to bins of (for example) a 5% series such as 1.8, 2.0,2.2,2.4,2.7 uF, etc. The bin assignments can be displayed, for guidance in hand sorting, or (with an interface option) output automatically to a handler for mechanized sorting.

Up to 8 regular bins are provided for categories of the principal measurement (RLC), in addition to a bin for rejects in the secondary measurement (QD), and a bin for all other rejects; total = 10 bins.

NOTE: The 1658-9620 IEEE/handler interface option provides only eight "go" bin output signal lines. Thus, an automatic handler can sort into bins 1 through 8.

Manually entered limits are normally entered in pairs (defining the upper and lower limits of a bin), in the form of "nominal value" and "percent" above and below that nominal. If only one "percent" value is entered for a bin, the limit pair is symmetrical (such as +/- 2%). To set up a non-symmetrical pair of limits, two "percent" values must be entered, the higher one first. Any overlapping portion of 2 bins is automatically assigned to the lower-numbered bin.

For simple GO/NO-GO testing, set up a QD limit and one regular bin. Entry of limits in additional bins will define additional GO conditions. Be sure the unused bins are closed. (Bins 0 thru 8 are initially zero, at power-up. This means that the default QD limit is "all fail" for D and Q with R; it is "all pass" for Q with L; and that bins 1 through 8 are initially closed.)

The test frequency can be selected after limits are entered, before any particular measurement.

### 3.8.2 Sorting Methods

### Figures 3-9, 3-10.

The figures illustrate 2 basic methods of sorting: nested and sequential.

Nested limits (Figure 3-9) are the natural choice for sorting by tolerance around a single nominal value. The lower numbered bins must be narrower than the higher numbered ones. Symmetrical limit pairs are shown; but unsymmetrical ones are possible. (For example, range BE could be assigned to bin 3 and range AF to bin 4 by use of unsymmetrical limit pairs in these bins.)

Sequential limits (Figure 3-10), on the other hand, are the natural choice for sorting by nominal value. Any overlap is assigned to the lower numbered bin; any gap between bins defaults to bin 9. The usual method of entry uses a redefined nominal value for each bin, with a symmetrical pair of limits. If it is necessary to define bins without overlap or gaps, use a single nominal value and unsymmetrical limit pairs. It is possible to set up one or more tighter-tolerance bins within each member of a sequence.

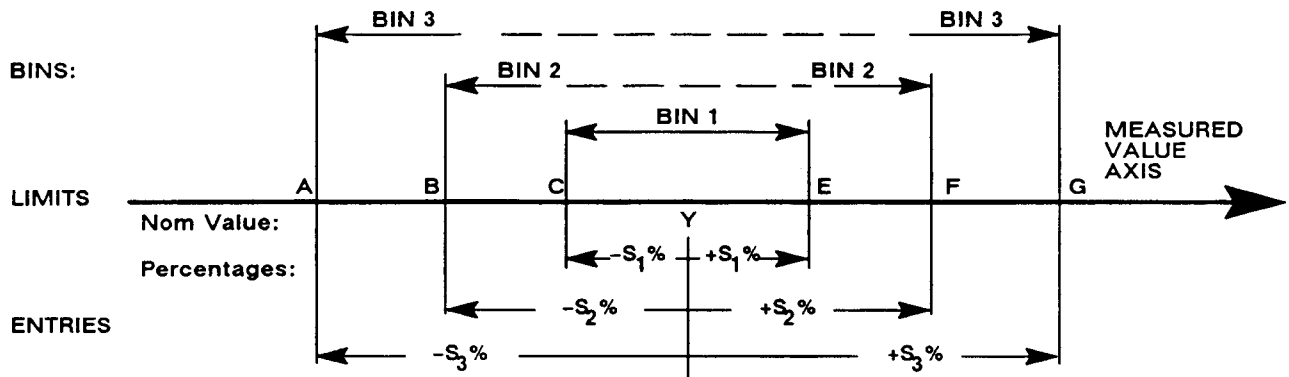

60035.0

Figure 3-9. Nested limits. A single nominal value Y is used and all limit pairs are symmetrical in this basic plan.



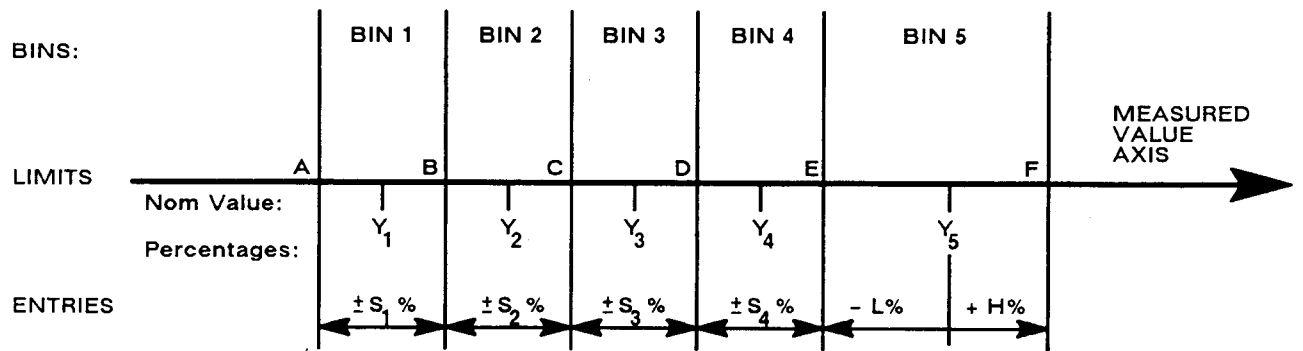

60036.0

Figure 3-10. Sequential limits. A different nominal value ( $Y_1, Y_2, Y_3, Y_4,$  and  $Y_5$ ) is entered for each bin and all limit pairs are symmetrical except for the unsymmetrical pair shown for example in bin 5.

Bucket sorting means sorting into bins that are not nested. The usual method is that mentioned above, sequential limits. However, there is no requirement that the bins be adjacent. Any of them can be defined with its own specific limits, which may be overlapping, adjacent, or isolated from any other bin.

### 3.8.3 Limit Entry Procedure

This procedure makes use of the limit entry keys (NOM VAL and BIN NO) at the left of the [SHIFT] key. These are labeled in yellow and apply only when the selected FUNCTION is ENTER.

#### *QD Limit*

Entering QD limit is performed as follows:

a. Press [DISPLAY] key to select VALUE. Press [FUNCTION] key to select ENTER.

b. To enter a single QD limit (always bin 0): press the parameter key (such as [L/Q]) appropriate to DUT. To change range and unit multipliers, press the same key repeatedly. (Refer to paragraph 3.3.4 for a table of units and multipliers, which indicates the sequence of multipliers that will appear.)

This entry can be a maximum limit or minimum limit depending on the parameter selection. Q is a maximum with R and a minimum with L. D is always a maximum.

c. When keying a number in, it will be shown on the left-hand display. For example, to enter a Q limit of 85, press:

[8][5] [=] [SHIFT] [BIN NO] [0].

The value now moves to the right-hand display, confirming storage of the limit. Note: if

you make a mistake, press the parameter key again and repeat the entry.

## NOTE

If at any time during the entry of a limit the wrong key is depressed, another way to clear and start the entry again is:

With the [FUNCTION] key, select IVEASURE momentarily and then ENTER again. Begin the entry anew.

*RLC Limits* The following will describe (with examples) three common methods of sorting that are possible with the 1659 Digibridge.

Nested bins -Using the same nominal value with symmetrical or unsymmetrical limit pairs.

Sequential bins -Using a different nominal value with symmetrical or unsymmetrical limit pairs.

Sequential bins -Using the same nominal value with adjacent, but non-overlapping limits.

1. Nested Bins. Enter the nominal value of DUTs to be sorted. (The value appears on the RLC display. Units were selected in step b.) For example, to enter 123.40 as the nominal value, press

[1][2][3][.][4][=] [SHIFT] [NOM VAL].

Enter for bin 1 the narrowest percent tolerance to be sorted. As an example, for a tolerance of +/-0.2%: press

[.] [2] [%][=] [SHIFT] [BIN NO][1].

The numerical limits are automatically computed and rounded-off values appear on the Digibridge displays (upper limit at the left, lower at the right).

For bin 2, enter the next wider tolerance, similarly. (Use 1 digit for the bin number.) Repeat the procedure for bins 3, 4, 5, ...up to a maximum of 8 bins.

EXAMPLE: To enter a set of nested limits, operate the keyboard as described below for the example of inductors having  $Q > 21$ ,  $L_s = 33 \text{ mH}$  +/- 0.35%, +/- 1%, +/- 5%, +7 -9%. Note that the last set of limits (+7 -9%), are unsymmetrical, whereas the others are symmetrical. In this case always enter the more positive tolerance first.

1. With [FUNCTION] key, select ENTER.
2. With [EQUIVALENT CIRCUIT] key, select SERIES.
3. With parameter key [L/Q], select RLC units: mH.
4. Enter Q limit thus: [2][1][=] [SHIFT] [BIN No.] [0].
5. Enter nominal RLC value: [3][3] [=] [SHIFT] [NOM VALUE]
6. Set bin 1 limits: [.] [3][5][%] [=] [SHIFT] [BIN No.][1].
7. Set bin 2 limits: [1] [%] [=] [SHIFT] [BIN No.] [2].
8. Set bin 3 limits: [5][%] [=] [SHIFT] [BIN No.] [3].
9. Set bin 4 limits: [7][%] [-] [9][%] [=][SHIFT] [BIN No.] [4].
10. Close bin 5 (if open): [0] [%] [=] [SHIFT] [BIN No.][5].
11. Close bins 6 through 8, similarly, if used before.

b. Sequential Bins (different nominal value). In this case a different nominal value is selected for each bin. The advantage of this method is that there is a straightforward definition of each bin in terms of percentages of the bins nominal value. The disadvantage is that overlaps or gaps in coverage among several bins are not obvious. (Remember that overlaps default to the lower-numbered bin; gaps default to bin 9.) Example: For sorting capacitors into part of the standard 5% series, setting  $D < .005$ , and nominal values for the bins at  $C_s = 0.91, 1.0, 1.1, 1.2, 1.3 \mu\text{F}$ .

1. With [FUNCTION] key, select ENTER.
2. With [EQUIVALENT CIRCUIT] key, select SERIES.
3. With parameter key [C/D], select units:  $\mu\text{F}$ .
4. Enter D limit: [.] [0] [0] [5] [=] [SHIFT] [BIN No.][0].
5. Enter nominal C value: [.] [9] [1] [=] [SHIFT] [NOM VALUE].
6. Set bin 1 limits: [5] [%] [=] [SHIFT] [BIN No.][1].
7. Redefine nominal: [1] [=] [SHIFT] [NOM VALUE].
8. Set bin 2 limits: [5] [%] [=] [SHIFT] [BIN No.][2].
9. Redefine nominal: [1] [.] [1] [=] [SHIFT] [NOM VALUE].
10. Set bin 3 limits: [5] [%] [=] [SHIFT] [BIN No.][3].
11. Redefine nominal: [1] [.] [2] [=] [SHIFT] [NOM VALUE].
12. Set bin 4 limits: [5] [%] [=] [SHIFT] [BIN No.][4].
13. Redefine nominal: [1] [.] [3] [=] [SHIFT] [NOM VALUE].
14. Set bin 5 limits: [5] [%] [=] [SHIFT] [BIN No.][5].
15. Close bin 6 (if open): [0] [%] [=] [SHIFT] [BIN No.][6].
16. Close bins 7 and 8, similarly (if used before).

NOTE: Because there are overlaps, bin numbers affect the binning (if a DUT satisfies two bins, it goes into "the lower-numbered bin"); for example, 1.046  $\mu\text{F}$  will go into the 1.0- $\mu\text{F}$  bin (No.2) because it is numbered lower than the 1.1- $\mu\text{F}$  bin (No.3).

c. Sequential Bin (same nominal value). In this case the same nominal value is selected for each bin. The advantage of this method is that all bin limits are related to the same nominal value, making it easy to define bins exactly adjacent to each other without overlaps or gaps. The disadvantage is that each bin is not readily defined in terms of its own nominal value.

Example: For sorting capacitors into six adjacent "I %" bins from -3% to +3%, setting  $D < .005$ , and nominal value of the six bins at  $C_s = 1.0 \mu\text{F}$ .

1. With [FUNCTION] key, select ENTER.
2. With [EQUIVALENT CIRCUIT] key, select SERIES.
3. With parameter key [C/D], select units:  $\mu\text{F}$ .
4. Enter D limit: [.] [0] [0] [5] [=] [SHIFT] [BIN No.] [0].
5. Enter nominal C value: [1] [=] [SHIFT] [NOM VALUE].
6. Set bin 1 limits: [-] [2] [%] [-] [3] [%] [=] [SHIFT] [BIN No.][1].
7. Set bin 2 limits: [-] [1] [%] [-] [2] [%] [=] [SHIFT] [BIN No.][2].
8. Set bin 3 limits: [0] [%] [-] [1] [%] [=] [SHIFT] [BIN No.][3].
9. Set bin 4 limits: [1] [%] [0] [%] [=] [SHIFT] [BIN No.][4].
10. Set bin 5 limits: [2] [%] [1] [%] [=] [SHIFT] [BIN No.][5].
11. Set bin 6 limits: [3] [%] [2] [%] [=] [SHIFT] [BIN No.][6].
12. Close bin 7 (if open): [0] [%] [=] [SHIFT] [BIN No.][7].
13. Close bin 8, similarly (if used before).

NOTE: For any bin the less negative or more positive percentage must be entered first as shown clearly in steps 6 and 11. Because there are no overlaps, there will be no "default assignment to the lower-numbered bin". Bin-number sequence is immaterial.

### 3.8.4 Verification of Nominal and Limit Values

While the function is ENTER, the exact values entered into the Digibridge can be seen by either of 2 methods, as follows.

*During the Entry Process.* A confirming display is automatically provided immediately after the final keystroke of each entry step. For example, after the [NOM VALUE] keystroke, the entered value appears on the RLC display. After the [BIN NO] and number keystrokes, the actual limits of RLC value (not percentages) appear across the full display area: upper limit on the regular RLC display, lower limit (4 most significant digits) in the regular QD display area. For bin 0, the QD limit appears in the QD area.

*Upon Demand.* To see the current "nominal value", depress the [SHIFT] [NOM VALUE] key (while the ENTER indicator is lit). To see the limits in any particular bin (or to verify that it has been closed), depress [SHIFT] [BIN NO] and the desired number, similarly. Displays selected in this way are limited by the units that are shown on the panel. For example, if the bin-3 limits are 162 and 198 nF, but the display units are pF, when you press [SHIFT] [BIN No.] [3], the display will go blank. Select either nF or uF (instead of pF) to obtain a display of these limits.

However, any nominal values" previous to the current one are lost and cannot be displayed (unless entered again). Bin limits are not lost until replaced by new entries in the particular bin; but they are normally lost when POWER is switched OFF. To prevent loss, lock the keyboard; see paragraph 3.9.

For comments on how bin sorting information is displayed, see paragraph 3.3.3.

### 3.8.5 Limit Measurements and Bin Assignments

- a. To measure a DUT with bin sorting:

Press the [FUNCTION] key to select MEASURE.

Press the [DISPLAY] key to select BIN NO.

Insert the DUT.

If the measure mode is TRIGGERED, press the START button.

Observe GO/NO-GO and bin-number results. GO indicates the DUT passed in bin 1, 2, 3 ...NO-GO indicates either QD failure (bin 0) or RLC failure (bin 9). See also paragraph 3.1.4.

For continued operation of the Digibridge, in MEASURE function, using the limits entered above, you can select any desired display, such as VALUE, or BIN No., with the [DISPLAY] key. (If you have the interface option, the available output data are not limited to the display selection.) The GO/NO-GO lights will operate unless you inhibit comparisons. (See below.)

- b. You can close any bin that has been opened (as in paragraph 3.8.3). For RLC bins, follow this example for bin 8, press:

0] [=] [SHIFT] [BIN NO] [8]

To disable QD sorting, close bin 0; thus, for D or Rs or Q with R, press:

[9] [9] [9] [=][SHIFT] [BIN NO] [0]

However, for Rp or Q with L, press:

)]=[SHIFT][BINNO] [0]

c. To enable GO/NO-GO lights after opening at least one bin, leave "nominal value" at any non-zero value. To disable GO/NO-GO and all bin sorting, press:

[0]=[SHIFT] [NOM VAL].

### 3.8.6 Summary on Limit Entries

For additional detail, refer to the condensed instructions on the reference card under the Digibridge, and to the following notes.

*Frequency.* It is NOT necessary to select the test frequency first. Comparison results are valid even if the test frequency is changed later in the entry/measurement procedure.

*Bin 0.* The limit entered in bin 0 is always QD. It is an upper or lower limit on the *secondary* measured value, depending on the parameter selection, as tabulated:

Rs/Q (upper)	Ls/Q (lower)	Cs/D (upper)
Rp/Q (upper)	Lp/Q (lower)	Cp/D (upper)

*Unsymmetrical Limit Pairs.* Enter 2 percentages for the bin. One or both may be + (unspecified sign) or -. Enter first the one that yields the larger absolute value of RLC.

*Unused Bins.* Initially, at power-up, bins 1 through 8 are closed so that unused ones can be ignored. Every unused bin that has previously been used must be closed by entering 0%, as in the above examples. Once closed, it will stay closed until non-zero percent limits are inserted.

*Allowable Limits.* A maximum of 6 significant figures for nominal value and per cent up to 99999.9.

#### NOTE

The two ranges (mF and Mohms) are display ranges only. When you try to enter a nominal value you are limited to uF or kohms. The maximum nominal for uF is 99999.9 or 100mF. Thus you cannot do a delta % or delta RLC for values larger than this, but you can do binning, if you figure it out. Say you want to bin +/- 10% of 1 farad:

Enter 99999.9 as nominal value (100mF). Enter 1000%800% = Bin 1 This will give you 1000% of 100mF + 100mF or 1100mF for the high limit and 800% of 100mF + 100mF or 900mF for the low limit. The same applies to Mohms.

*Bin Order.* Optional except for nested bins; be sure the narrower limit pairs go into lower numbered bins (because all overlap goes to the lower numbered bin).

*Inhibiting Comparisons.* To inhibit all comparisons, set nominal value to zero. (Then GO/NO-GO indicators stay off.) Subsequent setting of nominal value to any number except zero enables all comparisons as previously set up. To inhibit QD comparisons, set bin 0 to the "all-pass" extreme, i.e., to 0000 for Q with L; to 9999 for D or Q with R.

#### NOTE

When POWER is switched ON -if the keyboard is not locked -nominal value is initialized at zero. Therefore, all bin sorting is initially inhibited.

*Changing Entries.* Enter new value(s) -or a zero -to delete obsolete or erroneous nominal value or bin limits. Do not attempt to change or enter a single separate upper or lower limit in a bin, because any single percentage entered for a bin will be interpreted as a symmetrical pair of limits. Changing nominal value does not change any limits, but does determine the base for subsequent limit entries for specific bins. (After function is changed to :MEASURE, this nominal value will also serve as reference for delta percent measurements.)

*RLC Unit Selection.* In limit entry procedures, it is NOT necessary to select the range that the Digibridge will use in measuring. Just be sure that the number you enter for nominal value is suited to the units and unit multiplier indicated on the display panel. For example, nominal values of .033 H, and 33 mH are equivalent.

### 3.9 KEYBOARD LOCK, FUNCTION MAP, AND SUMMARY OF INTERROGATIONS

#### 3.9.1 Keyboard Lock

Locking the keyboard provides security against unintentional or unauthorized change in the keyboardselectable test conditions, as well as preserving them during the time that POWER is switched OFF.

Indications of the unlocked or locked state are as follows:

Unlocked --several keyboard indicators lit.

Locked --NO keyboard indicators lit, except possibly MEASURE, BIAS ON and/or REMOTE CONTROL.

To lock the keyboard, first select :MEASURE function. Then, press the following keys *deliberately*. The command sequence is the same to lock and to unlock:

[6] [5] [9] [=] [LOCK]

#### NOTE

If the REMOTE CONTROL indicator is lit, the keyboard may have been deactivated by remote command, in which case the way to reactivate it is by remote command. Refer to paragraph 3.11.

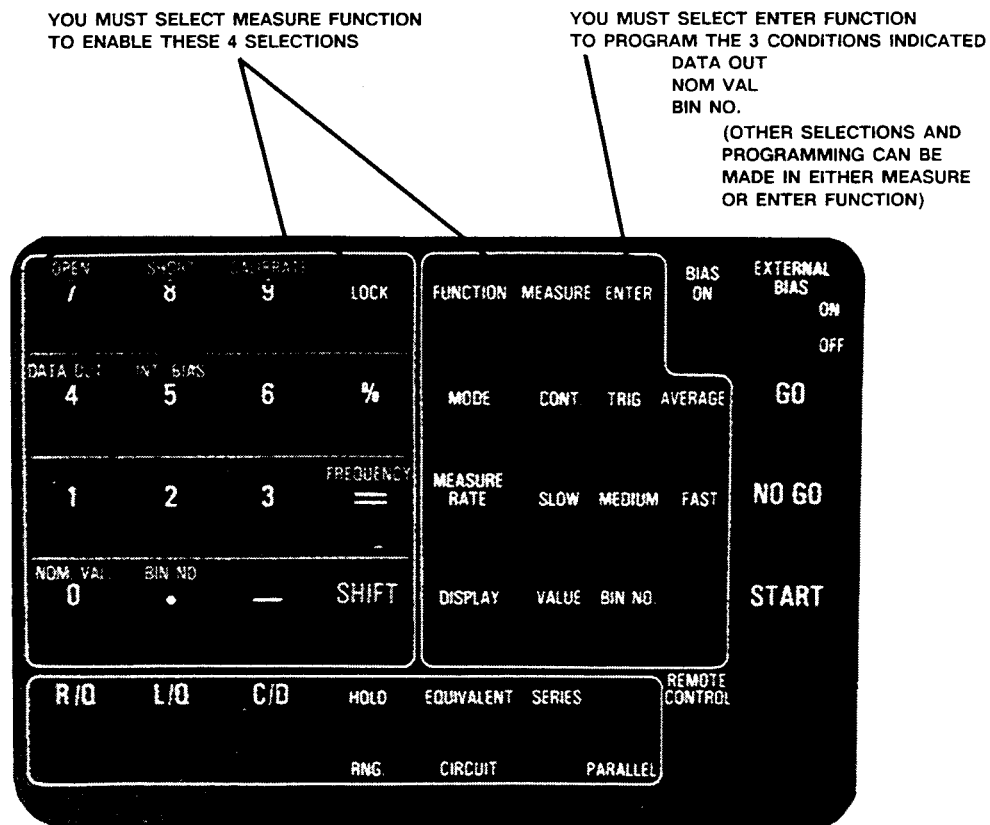

Figure 3-11. Map of keyboard, showing which programming entries can be made in MEASURE function and which ones in ENTER function.

### 3.9.2 Function Map

Figure 3-11.

The figure shows graphically (like a map of the keyboard) which programming keys are enabled in the MEASURE function and which ones in the ENTER function. Notice that two keys [INT BIAS] [FREQUENCY] inside the square 16-key area and all of the keys outside of that square are enabled *regardless* of any selection by the [FUNCTION] key.

### 3.9.3 Summary of Interrogations

Certain status (and results) information is indicated automatically on the display panels. For example:

Indicators below RLC display	---	units of measurement.
Indicators above RLC display	---	parameter of measurement.
Indicators above DQ display	---	parameter of measurement
	---	autoranging disabled
Indicators to the right of DQ display	---	test frequency
Measure indicator only lit	---	keyboard is locked
Left display "0", right also "0", GO	---	open-circuit zeroing enabled
Left display "5", right also "5", GO	---	short-circuit zeroing enabled
Left display "6", right also "6", GO	---	calibration enabled
Left display "0 14", right "blank"	---	measurement signal overload
Left display "22222", right "1111"	---	convertor/detector malfunction
Left display "22222", right "2222"	---	convertor/detector malfunction

The preceding three lines are explained in paragraph 3.13.3. Indicators on the keyboard provide important information, NOT summarized here.

The following interrogations will work only if you select ENTER function:

[SHIFT] [NOM VAL]	---	stored nominal value (appears displayed at left)
[SHIFT] [BIN NO] [1]	---	limits for bin 1 (both displayed, left and right)
[SHIFT] [DATA OUT]	---	code for data output via IEEE-488
[SHIFT] [LOCK] [CALIBRATE]	---	version number of Digibridge internal software (display format X.XX) when IEEE option is installed.
[SHIFT] [LOCK] [DATA OUT]	---	IEEE address (2 digit display)

### 3.10 OPERATION WITH A HANDLER

If you have the interface option (1658-9620 IEEE-488 BUS/HANDLER INTERFACE) and have made the system connections to a handler (paragraph 2.7), the Digibridge operating procedure is as follows.

a. Set up the handler either of two ways: indexing on EOT or indexing on ACQ, as explained below. The handler must supply a signal (here called "start next measurement") when it has completed connection of the DUT.

*Indexing on EDT.* Set up the handler to respond to the EOT signal from the Digibridge, which occurs at the "end of test", when the bin assignment is available for sorting. Set up the Digibridge to receive its START signal from the handler's "start next measurement" signal. This setup is simpler than the one below.

*Indexing on ACQ.* Set up the handler to respond to the ACQ signal from the Digibridge, which occurs after the "data acquisition" is complete. The handler can then remove the DUT from the test fixture and replace it with another DUT, while the Digibridge is calculating the result.

In addition, set up an interface that provides a START signal to the Digibridge by logical combination of the EOT signal from the Digibridge AND the "start next measurement" signal from the handler. Indexing on ACQ results in higher measurement rate than indexing on EOT.

b. Program the Digibridge for binning, as described in paragraph 3.8.



NOTE: Be sure to leave a non-zero number as "nominal value" in the Digibridge's memory, to enable the GO/NO-GO indicators and the EOT signal.

c. If measured values are not needed, select BIN NO. with the [DISPLAY] key. This selection saves 6 to 10 ms for each measurement, compared to other displays.

However, if measured values are to be monitored visually, select VALUE with the [DISPLAY] key. The displays are useful for incidental monitoring of measurements while the handler automatically sorts the parts being processed.

d. Select MEASURE function and TRIGGERED mode. This mode minimizes the time between insertion of the DUT into the test fixture and beginning of a valid measurement. Measurement starts when the Digibridge receives the START signal from the handler (or when the START button is pressed).

e. Select other measurement conditions as desired: EQUIVALENT CIRCUIT, RANGE HELD or autorange, MEASURE RATE, test FREQUENCY.

f. Enabling IEEE-488 output adds several milliseconds of calculation time to each measurement cycle: about 2 to 12 ms depending on the type of data. For measurement time considerations, refer to paragraph 3.5.

### **3.11 DATA OUTPUT AND/OR PROGRAMMING VIA IEEE-488 BUS**

These considerations apply only if you have an interface option. (If you do, there will be interface connectors at the rear. See Figure 1-3.)

#### **3.11.1 IEEE-488 Interface Unused**

If there is no system connection to the IEEE-488 INTERFACE connector, be sure to keep the TALK switch set to TALK ONLY.

#### **3.11.2 Talk-Only Use, for Data Output**

This pertains to a relatively simple system, with the Digibridge sending data out to one or more "listen-only" (IEEE-488 compatible) devices such as a printer.

a. Set the TALK switch to TALK ONLY.

b. Program the Digibridge to send out results automatically after each measurement. The commands for this purpose can be executed only in ENTER function, as follows.

[1]	[=]	[SHIFT]	[DATA OUT]	(for bin numbers)
[2]	[=]	[SHIFT]	[DATA OUT]	(for QD)
[3]	[=]	[SHIFT]	[DATA OUT]	(for QD and bin numbers)
[4]	[=]	[SHIFT]	[DATA OUT]	(for RLC)
[5]	[=]	[SHIFT]	[DATA OUT]	(for RLC and bin numbers)
[6]	[=]	[SHIFT]	[DATA OUT]	(for RLC and QD)
[7]	[=]	[SHIFT]	[DATA OUT]	(for RLC, QD, and bin numbers)
[8]	[=]	[SHIFT]	[DATA OUT]	(no output on PASS, full data set on FAIL)
[9]	[=]	[SHIFT]	[DATA OUT]	(BIN data on PASS, full data set on FAIL)
[0]	[=]	[SHIFT]	[DATA OUT]	(for no data output via IEEE-488 bus)

Operate the Digibridge in the usual way (manually). The system may constrain operation in some way. For example, a slow printer will limit the measurement rate because it requires a certain time to print one value before it can accept the next.

Refer to Table 3-5 for examples of the interface message code for data transfer. This table shows typical codes, but does not repeat the entire ASCII code. (There is a more complete table, in paragraph 2.8.)

*Output Formats for RLC, QD, and BIN NO. Results.* Refer to the following tables for formats of the output data (for the most recent measurement). Table 3-6 shows the format for RLC, Table 3-7 for QD, and Table 3-8 for BIN NO. If output of results has been enabled, by DATA OUT as described above (or XI... X9 command; see paragraph 3.11.3, Table 3-11), the Digibridge sends data to the IEEE bus at the completion of each measurement sequence. The character string for RLC value has the length of 17 characters; for QD value, 17 characters; for BIN NUMBER, 10 characters, including spaces, carriage return, and line feed characters.

NOTE

For a description of the compacted binary data output format (which saves time), refer to paragraph 3.11.4.

**Table 3-5**  
**ABBREVIATED INTERFACE MESSAGE CODE FOR "TALK-ONLY" DATA TRANSFER**

Character (ASCII)	Decimal Equiv	DI08	DI07	DI06	DI05	DI04	DI03	DI02	DI01
A	65	0	1	0	0	0	0	0	1
B	66	0	1	0	0	0	0	1	0
C	67	0	1	0	0	0	0	1	1
-----		etc		-----					
1	49	0	0	1	1	0	0	0	1
2	50	0	0	1	1	0	0	1	0
3	51	0	0	1	1	0	0	1	1
-----		etc		-----					

Table 3-6  
DATA OUTPUT FORMAT FOR RLC VALUE

Character Sequence	Purpose	Allowed Characters	Meaning
1	Status	(space) U O E I	Normal operation, measurement on a basic range Underrange held (reduced accuracy)* Overrange held (reduced accuracy) * End extension of range 1 or 4 (reduced accuracy) ** Invalid measurement due to signal overload
2	Value	(space)	Normal display
3	Parameter	L C R	Inductance Capacitance Resistance
4	Normal	(space)	Normal mode (as described above)
5,6	Units	(space)H mH mF uF nF pF (space)% (space)O KO MO	Henries Millihenries Millifarads Microfarads Nanofarads Picofarads Percent difference from nominal value Ohms Kilohms Megohms
7	Format	(space)	
8	Sign	(space) -	Positive R, L, C Negative R, L, C
9...15	Number	012345 6789. (space)	Measured number, right justified in format field; like the RLC display except the zero before the decimal point is explicitly provided and this number can be as long as seven characters. ***
16 17	Delimiter	(CR) (LF)	The standard "carriage return" and "line feed" characters; end of string.

-FOOTNOTES FOR TABLE 3-6

\* Underrange generally occurs when the measured impedance is lower than the normal low limit (for automatic range change) and there is a lower-impedance range. Overrange generally occurs when the measured impedance is higher than the normal high limit (for automatic range change) and there is a higher-impedance range. In either case, an appropriate range change will improve accuracy. If there is no appropriate range to change to, the status is "range end extension"; see below.

\*\* No possibility of changing range to improve accuracy. DUT impedance has reached a point where the accuracy HIGH Z or LOW Z terms may be significant. Refer to accuracy specifications in the front of this manual.

\*\*\* If the measurement is outside of the display range (display goes blank), 9999999 is output in this numeric field.

Table 3-7  
QD-VALUE DATA OUTPUT FORMAT

Character Sequence	Purpose	Allowed Characters	Meaning
1	Status	(space) 0 I	Normal operation Overrange of QD display Invalid measurement due to signal overload
2	Format	(space)	
3	Parameter	Q D	Quality factor Dissipation factor
4	Format	(space)	
5...7	Units	(2 spaces)0 (space)kO (3 spaces)	Ohms Kilohms Dimensionless (for Q or D)
8	Sign	(space) -	Positive QD value Negative QD value
9...15	Number	012345 6789. (space) **	Measured number, right justified in format field; like the QDR display except the zero before the decimal point is explicitly provided and this number can be as long as six characters plus decimal point. *
16	Delimiter	(CR)	The standard "carriage return" and "line feed" characters; end of string.
17		(LF)	

\* If measurement is overrange (display goes blank), 999999 is output in this field.

\*\* Two leading zeros will precede the decimal point on values less than 1. Two spaces will precede the value on values greater than 1.

Table 3-8  
BIN NUMBER DATA OUTPUT FORMAT

Character Sequence	Purpose	Allowed Characters	Meaning
1	Pass/Fail	(space) F	Go (any of: bins 01 through 08) No-Go (bin 00 or bin 09).
2	Format	(space)	
3	Label	B	The word "BIN".
4		I	
5		N	
6	Format	(space)	
7,8	Bin Number	0123456789	Bin number assignment, 00 to 09.
9	Delimiter	(CR)	The standard "carriage return" and "line feed" characters; end of string.
10		(LF)	

### 3.11.3 Talk/Listen Use, for Remote Programming and Data Transfers

Observe the REMOTE CONTROL indicator light. If it is lit, there is no opportunity for manual operation (except switching EXTERNAL BIAS ON and OFF and use of the START button if manual start is enabled.) The displays may be observed then, but their content is controlled by the system controller, via the IEEE-488 bus.

Details of test program preparation are beyond the scope of this manual. Refer to Table 3-12 for an example of message activity during a control sequence in which the controller says "start" and the Digibridge (after a measurement) says "C uF 1.2345".

*Programming Guidelines.* If the Digibridge is to be programmed (TALK switch set to TALK/LISTEN), keep the following suggestions in mind.

1. An "unlisten" command is required before measurement is possible.
2. If not addressed to talk, the Digibridge sends a service request (SRQ low) when it has data ready to send.
3. Then SRQ will not go false (high) until the Digibridge has been addressed to talk or has been serially polled. A typical program might include these features:

Initial Setup: with ATN true, "untalk unlisten, my listen address (of Digibridge), my talk address (of CPU)"; then with ATN false, measurement conditions.

Measurement Enabling Sequence, for example: untalk the Digibridge, send a GET, unlisten the Digibridge.

After the CPU receives the SRQ, necessary enabling of data transfer: with ATN true, "untalk, unlisten, my listen address (of CPU), my talk address (of Digibridge)"; then ATN false.

*Serial Poll -Status Byte -Table 3-10.* When the bus is in the serial poll mode and the Digibridge is addressed to talk, the Digibridge responds with a status byte, which is encoded as shown in the table and sent on the data lines DI01 through DI08.

**Table 3-9  
INTERFACE MESSAGE CODE FOR REMOTE CONTROL**

Message code	Note *	ASCII Equiv **	Decimal Equiv ***	Sent concurrently with ATN line true:							
				DI08	DI07	DI06	DI05	DI04	DI03	DI02	DI01
MLA	Set # Tot (SP) to >		35 32 to 62	X	0	1	0	0	0	1	1
							<MSB--device-address--LSB>				
MTA	Set C Tot @ to ^		67 64 to 94	X	1	0	0	0	0	1	1
							<MSB--device-address--LSB>				
SPD	-- (EM)		25	X	0	0	1	1	0	0	1
SPE	-- (CAN)		24	X	0	0	1	1	0	0	0
UNL	-- ?		63	X	0	1	1	1	1	1	1
UNT	-- --		95	X	1	0	1	1	1	1	1

Because the following messages are addressed commands, they will affect the Digibridge operation only while it is addressed to listen. \*\*\*\*

GET	-- (BS)		8	X	0	0	0	1	0	0	0
GTL	-- (SOH)		1	X	0	0	0	0	0	0	1

\* Mnemonic key to codes: MLA = my listen address; MTA = my talk address; SPD = serial poll disable; SPE = serial poll enable; UNL = unlisten; UNT = untalk; GET = group execute trigger; GTL = go to local.

\*\* Set = address setting as supplied by factory; Tot = total range of choice.  
See paragraph 2.8 for address changing procedure.

\*\*\* Decimal equivalent makes DI08 (which is immaterial) a zero. Logical 1 is low state (true); logical 0 is high.

\*\*\*\* Digibridge is addressed to listen by MLA message containing its device address. (See paragraph 2.8.) It terminates this condition when it receives UNL command, which is necessary before it can make measurements or recognize its own keyboard.

Table 3-10  
STATUS CODE

Line	Significance of a "1" (Low)	Significance of a "0" (High)
DI08	Remote.	Local.
DI07	Request for service, RQS. (This device asserted SRQ.)	No request by this Digibridge for service.
DI06	Recalibration required.	Normal operation.
DI05	Busy, measurement in process.	Measurement completed.
DI04	Limits were tested.	Limits were not tested.
DI03	RLC measured value is available.	RLC value is not available.
DI02	QD measured value is available.	QD value is not available.
DI01	Bin No. assignment is available.	Bin No. assignment is not available.

*Instrument Program Commands.* The set of commands used in remote programming is an input data code to which the instrument will respond as a "talker/listener", after being put into a remote-control mode via the bus (see Table 3-9) and addressed to listen to device-dependent command strings.

Refer to Table 3-11. The programming command set includes all of the keyboard functions except switching external bias ON/OFF and full recalibration, which are not remotely programmable. Keyboard functions are explained above, particularly in paragraphs 3.3, 3.4, 3.8, 3.9, 3.10; and most of these commands are related to them in an obvious way.

Zero calibration by remote control is similar to the manual procedure. The "Z1" command is equivalent to manually keying

[1][6][5][9][=] [SHIFT] [OPEN]

It is necessary to allow the Digibridge to reach range 1. (It must not be held on another range.) The test fixture must be physically open-circuited. Zero calibration is initiated by a "G0" command (equivalent to pressing START), which should not be followed by other commands until the Digibridge responds with "SRQ". (The purpose of the "Z0" command is to defeat the preceding "Z1" command, as you might wish to do if the "Z1" was sent by mistake.)

Limit entry commands are interpreted in relation to the previously established parameter; send the 'M' command first. Use the limit entry commands in the tabulated sequence, except that nominal value need not be repeated after once being entered.

Notice that f, n, h, and I in the table are "E-notation" numbers, containing any number of digits, with optional use of decimal point and optional use of power-of-ten multiplier. Do NOT omit the semicolon after each of these. (Refer to the table.) The letter n in the table is nominal value in base units (ohms, farads, or henries). For example, nominal value can be set to 543.21 pF by the command:

N543.21E-12;



Limits for bins 1 thru 8 are entered using percentages, referred to the current nominal value. For example, Bin No. 1 (designated 1) is set to +1.5%, -.05% by the command sequence:

B1H1.5;L-5E-2;

However, the limit for Bin Zero (the desired upper limit for D or Q with R, lower limit for Q with L) is entered as a value (dimensionless for D or Q, ohms for R). For example, Bin Zero is set to .001 (with parameter selection C/D) by the command:

B0H1E-3;

There are three types of commands: two-byte, three-byte, and floating-point, as described below. Each byte is coded according to the 7-bit ASCII code, using the DI01...DI07 lines. The most significant bit is DI07, as recommended by the Standard. (The eighth bit - DI08 - is ignored.) Thus, for example, the command for "MEASURE FUNCTION" is P0, having octal code 120 followed by 060. The two 7-bit binary bytes are therefore: 1 010000 and 0 110000.

Note: The ASCII code -"X3.4-1968, Code for Information Interchange" -is available from American National Standards Institute, 1430 Broadway, New York, N.Y. 10018. This code can be written out as follows. For the numerals 0, 1, 2 ...9, write the series of octal numbers 060, 061, 062 ...071; for the alphabet A, B, C... Z, write the series 101, 102, 103 ...132. (Refer also to the table in the paragraph about "Address", in 2.8.4.) The ASCII code conforms to the 7-bit code ISO 646 used internationally.

*Two Byte and Three Byte Entn.es.* These command entries, as shown in Table 3-11, are simple ASCII character sequences of two or three characters. The first character is a letter which designates the category of the entry. The following ASCII character -or two characters if this is a three-byte entry -are decimal digits (0 to 9) which convey information about the selection within the category. For example, the ASCII sequence *D2* means "in DISPLAY category, select VALUE." The command is like pressing the [DISPLAY] key to select VALUE.

## NOTES

1. The 2-byte command **P2** is recommended as the first command in a remote programming sequence because it resets all selections to their power - up (default) conditions.
2. The 2-byte command **P3** returns the Digibridge to the diagnostic routine and local control (i.e., the equivalent to a power-down, power-up cycle).

Table 3-11  
1659 DIGIBRIDGE IEEE-488 PROGRAMMING COMMANDS

Program Category	Program Selection	Command Entry	Program Category	Program Selection	Command Entry
DISPLAY:	VALUE * BIN #	D0 D1	NOM. VALUE:	n=Ohms, F, or H	Nn;
MEAS RATE:	Fast Medium Slow *	S0 S1 S2	BIN NUMBER:	b=bin#	Bb
FUNCTION:	MEASURE * Enter	P0 P1	INTERNAL	OFF *	U0
			BIAS:	On	U1
PARAMETER:	L/Q	M0	MEASURE	TRIGGERED *	T0
	C/D	M1	MODE:	Continuous	T1
	R/Q	M2		Average	T2
	AUTO SEL. *	M3			
DATA OUTPUT:	NONE *	X0	DATA FORMAT:	NORMAL *	x0
	Bin #	X1		Compacted	x1
	QDR	X2	MANUAL	ENABLE *	W0
	QDR, Bin #	X3	START:	Disable	W1
	RLC	X4			
	RLC, Bin #	X5	KEYBOARD	UNLOCK *	K0
	RLC, QDR	X6	LOCK:	Lock	K1
	RLC, QDR, Bin #	X7			
	Pass/none, Fail/all	X8	FREQUENCY:	1 kHz	F0
Pass/bin, Fail/all	X9		10 kHz	F1	
INITIATION:	(START)	G0		100 Hz	F2
				120 Hz	F3
			ZERO CAL:	Disable	Z0
				Open	Z1
EQUIV. CKT.	Parallel	C0		Short	Z2
	SERIES *	C1			
RANGE:	Hold range	R0	RESET:	Turn-On Conditions	P2
	Hold range 1	R1		Diagnostics	P3
	Hold range 2	R2			
	Hold range 3	R3			
	Hold range 4	R4			
	AUTO RANGE *	R5			

\* Turn-on conditions.

**Table 3-12**  
**MESSAGE ACTIVITY ON IEEE-488 BUS DURING A SIMPLE EXAMPLE OF REMOTE CONTROL**

Byte order	Message * line	ATN	Comment
-----			
1	(UNT)	true	Untalk all devices.
2	(UNL)	true	Unlisten all devices.
3 **	(MLA 3)	true	Set Digibridge (address 3) to listen.
4	(MLA n)	true	Set controller (address n) to talk.
5	G	false	Typical device-dependent message: START. (See
6	0	false	Table 3-11 for "program commands".)
7	(UNL)	true	Unlisten Digibridge (must for measurement).
--	--	--	Digibridge makes measurement, and asserts SRQ
--	--	--	line to indicate completion.
8	(MLA n)	true	Set controller to listen.
9 **	(MLA 3)	true	Set Digibridge to talk.
10	(space)		Typical data stream from Digibridge in
11	(space)		The format of Tables 3-6, 3-7 sent to
12	C		controller, which will execute
13	(space)		some kind of read command
14	u		(specified by programmer) according to
15	F		destination (such as a printer).
16	(space)		
17	(space)		
18	(space)		
19	1		
20	.		
21	2		
22	3		
23	4		
24	5		
25	(CR)		
26	(LF)		

\* Message on DI01...DI08 lines is coded and interpreted differently depending on simultaneous state of ATN line (true = asserted = low, false = high). See IEEE-488 interface key tabulated in paragraph 2.8.3.

\*\* Bytes 3 and 4 can be programmed in a single command to controller; bytes 8 and 9 similarly. Notice that we refer to factory-set address as "3" by reading a 5-bit binary number (lines DI05...DI01).

### 3.11.4 Data Output in Compacted Binary Format

The compacted binary format for data output can be selected to save time. Selection must be made via IEEE-488 bus, not via the keyboard. The time saving is indicated by the fact that this format conveys a full set of test results in 8 binary bytes, compared to 44 binary bytes required by the regular format. Fewer characters are sent if you select less than complete results (such as bin number only, output only for FAIL, etc).

The data stream for one measurement consists of two to eight 8-bit bytes, depending on what output is programmed. The format is explained partly in truth Table 3-13, and partly in the text that follows.

#### NOTE

The 8 bits in each byte are 76543210, where 0 is LSB (least significant bit). The vertical line or space between bytes is for clarity only, not present in data.

The full eight bytes are sent only if RLC, QD, and Bin information is needed (i.e., only if "status" bits 2,1,0 are logic 111). Otherwise, the data word is shortened, as follows.

If QD data are NOT needed, the data format uses 5 bytes as follows.

If both QD and BIN data are not needed, the "OTHER" byte is omitted.

Name :	STATUS	RLC, e	RLC, mantissa	OTHER
Byte Number :	byte 1	byte 2	byte 3 byte 4	byte 5
-----	-----	-----	-----	-----

If RLC data are NOT needed, the data format uses 5 bytes as follows.

If both RLC and BIN data are not needed, the "OTHER" byte is omitted.

Name :	STATUS	QD, e	QD, mantissa	OTHER
Byte Number :	byte 1	byte 2	byte 3 byte 4	byte 5
-----	-----	-----	-----	-----

If only BIN data are needed, the data format uses only 2 bytes, as follows.

If RLC, QD, and BIN data are all NOT needed, no data output occurs.

Name :	STATUS	OTHER
Byte Number :	byte 1	byte 2
-----	-----	-----

The *RLC,e* byte (except for bit 7) conveys the RLC exponent (2s complement).

The *RLC,mantissa* bytes (all 16 bits) convey the RLC mantissa (base 2).

The *QD,e* byte (except for bit 7) conveys the QD exponent (2s complement).

The *QD,mantissa* bytes (all 16 bits) convey the QD mantissa (base 2).

The binary exponent and mantissa define a binary floating-point number, as follows:

$$(\text{Sign}) ( 2^{(\text{exponent})} ) * (\text{mantissa} )$$

**Table 3-13**  
**TRUTH TABLE OF COMPACTED BINARY FORMAT FOR OUTPUT DATA**

Name:	STATUS	RLC, e	RLC, mantissa	QD, e	QD, mantissa	OTHER		
Byte Number:	byte 1	byte 2	byte 3	byte 4	byte 5	byte 6	byte 7	byte 8
-----	76543210	7-----	-----	7-----	-----	-----	-----	76543210
Normal meas	00							
Overrange	01							
Underrange	10							
Invalid meas	11							
Range 1	00							
Range 2	01							
Range 3	10							
Range 4	11							
	*							
Bin number	001							
QD	010							
QD & bin no.	011							
RLC	100							
RLC & bin no.	101							
RLC, QD, bin #	111							
RLC value is+	0							
RLC value is-	1							
QD value is +				0				
QD value is -				1				
Parameter L/Q								00
Parameter C/D								01
Parameter C/R								10
Value(default)								10
BIN 0								0000
BIN 1								0001
BIN 2								0010
BIN 3								0011
BIN 4								0100
(etc)								
(etc)								
BIN 9								1001

\* Bit 3 of STATUS byte does not convey data.

The following examples illustrate how to obtain ordinary (base-10) numbers from the compacted binary data.

**EXAMPLE 1.** (Bytes are shown separated by spaces.)

STATUS	RLC, e	RLC, mantissa		QD, e	QD, mantissa		OTHER
byte 1	byte 2	byte 3	byte 4	byte 5	byte 6	byte 7	byte 8
76543210	76543210	76543210	76543210	76543210	76543210	76543210	76543210
0001xlll	01100101	11100001	00001001	01110101	10100000	00000000	01100111

The example-1 interpretation is as follows:

Byte 1: Normal measurement. Range 2. RLC, QD, and bin number data are needed.

Byte 2, bit 7: Sign of 0 value is +.

Byte 2, other bits: 0 exponent is 1100101 in 2s complement notation, which is the same as a negative exponent of 011011 (i.e., -27, base 10).

NOTE 1: bit 6 is always 1 for a negative exponent, 0 for a positive exponent. Bytes 3, 4: 0 mantissa is .879044 (directly from the 16-bit binary number).

NOTE 2: In the mantissa, the first bit has the weight of 0.5, the next bit 0.25, the next bit 0.125, and each other bit half of the one before it, to the 16th bit.

Therefore, the 0 value is  $+ (2 \text{ to the } -27\text{th power}) * (.879044) = (7.45058) * (10 \text{ to the } -9 \text{ power}) * (.879044) = 6.54939 * 10 \text{ e}(-9) \text{ farads} = 6.5494 \text{ nF}$ . Bytes 5,6, and 7 (by the same method as bytes 2,3, and 4): D = .0003 Byte 8: Parameters are C/D. Data numbers are values (normal). Bin 7 assignment.

**EXAMPLE 2.** (Bytes are shown separated by spaces.)

STATUS	RLC, e	RLC, mantissa	
byte 1	byte 2	byte 3	byte 4
76543210	76543210	76543210	76543210
0010xOl0	00001010	10100011	00011100

The example-2 interpretation is as follows:

Byte 1: Normal measurement. Range 3. RLC data are needed.

Byte 2, bit 7: Sign of R value is +.

Byte 2, other bits: R exponent is 0001010 in 2s complement notation, which is the same as a positive exponent of 001010 (i.e., +10, base 10). (See NOTE 1, above.)

Bytes 3, 4: R mantissa is .637146 (from the 16-bit binary number; see NOTE 2, above).

Therefore, the R value is  $+ (2 \text{ to the } +10\text{th power}) * (.637146) = (1024) * (.637146) = 652.44 \text{ ohms}$ .

### 3.12 SAMPLE IEEE PROGRAMS

Below are three sample IEEE-488 programs using three different IEEE controllers. These programs are intentionally very short and are intended as aids to demonstrate to the programmer how to operate a Digibridge using a typical controller. It is assumed that the Digibridge address is set to 3.

#### 3.12.1 Programming Hints

- a. The initiation (start) command is "G0". That is the number 0, not the letter O.
- b. It is good practice to begin a new program with a "P2" command. This will reset all parameters to the known turn-on state. If "P2" is used later in the program, it will reset everything, including Nominal Value and any Bin Limits that may be set.
- c. An 'X' command must be sent to enable data output.
- d. The string "P2T2M2X4Z2G0" should be sent for the Short Circuit Zero. A frequency other than 1 kHz can be sent, if needed.
- e. The string "P2T2M1X4Z1G0" should be sent for the Open Circuit Zero. A frequency other than 1 kHz can be sent, if needed.
- f. All commands sent to the Digibridge must be followed by an UNL (unlisten) and then an ATN (attention) must be unasserted. If the instrument is set to TALK, this should happen automatically.

#### 3.12.2 Hewlett Packard HP85

```
100 REMOTE 703
110 OUTPUT 703 ; "P2X4G0 "
120 ENTER 703 ; C$
130 DISP C$
140 LOCAL 703
150 SEND 7 ; UNL @ RESUME 7
160 END
```

#### 3.12.3 Capital Equipment Corp. PC-488 Card With the IBM-PC

```
100 DEFINT A-Z
110 DEF SEG=&HC000
120 INIT=0 : TRANSMIT=3 : ENTER=21
130 MY.ADDR=21 : SYSTEM.CONTROL=0
140 DIGIBRIDGE=3
150 CALL INIT (MY.ADDR, SYSTEM.CONTROL)
160 REN$="REN"
170 CALL TRANSMIT (REN$, STATUS)
180 M$="P2X4G0 "
190 ST$="LISTEN 3 MEA DATA '"+M$+' ' UNL"
200 CALL TRANSMIT (ST$, STATUS)
210 R$=SPACE$(17)
220 CALL ENTER (R$, LENGTH, DIGIBRIDGE, STATUS)
230 PRINT " MEASUREMENT IS: ";R$
240 END
```

' PC-488 memory address  
' PC-488 commands  
' Initialize IEEE-488  
' Address of Digibridge  
' Enable remote control first  
' Command for Digibridge  
' Receive data  
' Print result

### 3.12.4 National Instruments GPIB-PCII Card With the IBM-PC

```
100 '*****INITIALIZE BRIDGE*****
110 ADAP$="GPIB0" : DIGI$="DIGI":V%=1
120 CALL IBFIND (ADAP$,GPIB0%): CALL IBSIC (GPIB0%)
130 IF IBSTA% < 0 THEN GOTO 120
140 CALL IBGTS (GPIB0%,V%)
150 CALL IBFIND (DIGI$,DIGI%)
160 CLS '*****MEASURE AND DISPLAY DATA*****
170 C$=SPACE$(20):D$=SPACE$(20)
180 SET$="P2X6G0" ' bridge setup string
190 CALL IBWRT (DIGI%,SET$) ' send string to bridge
200 CALL IBRD (DIGI%,C$): CALL IBRD (DIGI%,D$) ' read measurement results
' display results
210 PRINT C$;D$
220 CALL IBLOC (DIGI%) : CALL IBGTS (GPIB0%,V%) ' return to local control
230 END
```

### 3.13 SELF CHECKS AND FAILURE DISPLAYS (ERROR CODES)

#### 3.13.1 Power-Up Self Check

Every time the instrument is switched ON or the line voltage reappears after an interruption, the Digibridge keeps itself busy for a short time going through an automatic self-check routine. The RLC and QD displays indicate in code which check is being performed. It is possible to halt the diagnostic routine and hold the displayed code by pressing and holding the [SHIFT] key or other key. Normally these displays follow one another rapidly. However, if one of them persists, there has been a failure in the self check. The nature of the failure and the proper remedy for each are indicated below. Normal operation is inhibited in each of these cases.

#### NOTE

Operation can usually be enabled (in spite of failure messages other than 88888 or 33333) by pressing START button. This action is useful to enable measurements using a test capacitance or for certain transfer impedance measurements. But, it IS NOT RECOMMENDED unless you are well aware of what caused the self-check failure.

88888 8888. The random-access-memory read/write exercise was imperfect. Try power-up again; otherwise the remedy is beyond the operator's control; repair service is required.

77777 XXXX. The detector test was not completed satisfactorily. Be sure that the EXTERNAL BIAS switch is OFF; try power-up again. Otherwise the remedy is beyond the operator's control; repair service is required. (The QD display provides some service information indicating in code which of 4 important digital signals is stuck, and whether high or low.)

66666 XXXX. The detector scale test failed. CPU will loop on failure. Switch POWER OFF and ON again. If these remedies are ineffective, repair service is required.



555 D XXXX. A signal-strength check failed. When D is 1...4, it indicates the range being checked (with voltage = 1.275 V). When D is 5, the range is 4, with voltage = .075 V. CPU will loop on failure. Be sure that the EXTERNAL BIAS switch is OFF and check to make sure that the charged capacitor protective fuse has not blown (Item 11, Figure 1-2). Recycle power OFF and ON to exit from loop.

444 E XXXX. A check on test frequency and waveform failed. For E of 1, 2, 3, 4, 5, 6, the frequency being checked is 6.06, 6.0, 1.2, 0.48, .0968, .0118 kHz, respectively. CPU will loop on failure; recycle power OFF and ON to exit from loop.

33333 XXXX. PROM data checksum test. XXXX = checksum, which must be zero to pass the test.

222 F XXXX. Calibration constants test. XXXX = normalized value of constant, which must be within the limits of 1.00000 +/- 0.78125 to pass the test. For F = 0, the constant is frequency correction factor. For F = 1, 2, 3, or 4, it is the conductance of range 1, 2, 3, or 4, respectively.

You can proceed from this power-up self-check failure (222 F XXXX) and operate the Digibridge. To do so, press the [C/D] key. Of course, the measured results are liable to be erroneous; you should then proceed to obtain service to repair the fault and/or recalibrate.

### 3.13.2 Failure Display due to Signal Overload

"014 " (*right display blank*) Occurrence of an unrecoverable signal overload during the last measurement. This means that a signal overload occurred during RANGE HELD or while measuring on Range 4. Otherwise (if a

signal overload occurs on range 1, 2, or 3 and range is NOT held), this failure display is not shown; instead, the Digibridge will change to the next higher-numbered range and try again.

1. Transient voltage from charged capacitor.
2. Transient due to application of bias voltage.
3. Hardware failure.
4. LC resonance effect (measuring inductance).

### 3.13.3 Failure Display due to Abnormal Measurement Cycle

22222 xxxx. The Digibridge will abort the measurement and provide this display if there is (even once during a measurement) a converter/detector malfunction such that the integrator's conversion cannot be completed. There are two versions of this failure:

22222 2222. The cycle is "too long". Integrator voltage does not return to zero in reasonable time.

22222 1111. The cycle is "too short". Integrator voltage was already zero (or wrong polarity) when conversion began.

### 3.13.4 Failure Display due to LC Resonance

A display of "0 14 " or 22222 1111 can occur, in place of the expected L and Q, because the inductor being measured resonates with measuring circuit capacitance. (Resonance can cause an overload of the converter/detector.) The Digibridge thus presents an easily noticed failure display rather than an invalid measurement result.

*When Expected.* This resonance effect can be expected when large values of inductance are being measured at high frequency. In particular, if the Digibridge is autoranging, this effect could be expected in range 1.

This resonance effect can also be expected under some conditions of high-frequency measurement with range 1 held but the inductance of the DUT appropriate for range 2. The effect is NOT expected with autoranging in ranges 2, 3, 4, unless stray capacitance is considerably large.

It is possible for valid measurement, with a slight reduction in accuracy, to be made under conditions very close to those that will trigger the LC resonance failure display. Such a measurement can be expected to meet accuracy specifications if it is displayed at all.

*Recommended Procedure.* If this LC-resonance failure display appears, in the course of otherwise normal measurements, the instrument is functioning normally. Valid measurements can usually be made by taking one or more of the following steps.

a. Select a low-impedance range. For example, if measurement is normally in range 1, try holding range 2; or if range 1 has been held, select autorange.

b. Reduce the measurement frequency.

c. If cable and test fixture capacitance can be reduced, do so.

d. If this resonance effect is not easily avoided, consider that the DUT may be self-resonant. If so, unqualified measurements of apparent inductance are misleading. Try a set of measurements of apparent inductance at different frequencies sufficiently low (or high) to avoid the resonance failure display.

NOTE: If the RLC reading is negative, with indicated units of mH or H, the measured reactance is capacitive, although the RLC display is a number of millihenries or henries.

---

# Theory – Section 4

---

4.1 INTRODUCTION .....	4-1
4.2 PRINCIPAL FUNCTIONS .....	4- 4

## 4.1 INTRODUCTION

### 4.1.1 General

This instrument uses an unusual method of measurement, which is quite different from those used in most previous impedance meters or bridges. A thorough understanding of this method will be helpful in unusual applications of the instrument. The following paragraph gives a brief overall description outlining the measurement technique to one familiar with impedance measurement methods. A more detailed description of operation, specific circuitry, and control signals is given later.

### 4.1.2 Brief Description of the 1659 Digibridge.

This Digibridge TM RLC tester uses a patented measurement technique, in which a microprocessor calculates the desired impedance parameters from a series of 6 or 8 voltage measurements (6 for FAST, 6 for MED, and 8 for SLOW measurement rates). These measurements include quadrature (90 degree) and inverse (180 degree) vector components of the voltages across the device under test  $Z_x$  (the DUT), and across a standard resistor  $R_s$  carrying the same current as the DUT. Each of these voltage measurements is meaningless by itself, because the reference signals have no particular phase relationship to the measured analog signals, and because the current through  $Z_x$  is not controlled. Each set of voltage measurements is made in rapid sequence with the same phase-sensitive detector and analog-to-digital converter. Therefore properly chosen differences between these measurements subtract out fixed offset errors, and ratios between them cancel out the value of the common current, the scale factor of the detector-converter, and the effect of the relative reference-to-signal phase angle.

The phase-sensitive detector uses 4 reference signals, precisely 90 degrees apart, that have exactly the same frequency as the test signal, but whose phase relationship to any of the analog voltages or currents (such as the current through  $Z_x$  and  $R_s$ ) is incidental. Therefore, no precise analog phase shifter or waveform squaring circuit is required. Correct phase relationships are maintained by generating test signal and reference signals from the same high-frequency source.

Because of the measurement technique and circuitry, the only calibration adjustment in the Digibridge is the factory setting of the test-voltage-level reference. The only precision components in this instrument are four standard resistors and a quartz-crystal stabilized oscillator. There is no reactance standard. For example, C and D are calculated by the microprocessor from the set of voltage measurements, the predetermined frequency, and the calibrated  $R$  and  $Q$  of the applicable standard resistor.

In these calculations, the microprocessor automatically removes from the measured result the parameters of the test connection ("stray" capacitance and conductance and series resistance and inductance), if simple open-circuit and short-circuit "ZERO" calibration measurements have been performed by the operator. The values obtained during "ZERO" calibration are stored in Digibridge memory and retained during power-down and power-up.

The impedance of each internal standard resistor is similarly stored in memory for use by the microprocessor in the calculation of parameters being measured. (For this purpose, the Digibridge measures its own internal standard resistors against an external standard during factory calibration ---and recalibration, if any.) Therefore, the impedances of the internal resistance standards are known at the calibration frequency (usually 1 kHz), and are computed by the microprocessor for other test frequencies.

The Digibridge also stores the frequency error of its crystal-referenced oscillator (actual vs nominal frequency, expressed in parts per million) so that the microprocessor uses a corrected frequency value in each calculation of capacitance or inductance from measured impedance. This frequency correction is programmed into the Digibridge during factory calibration --and recalibration, if any.

The microprocessor controls the measurement sequence, according to programs in the read-only memory, using stored operator selections that are made available through keyboard control or (if you have the interface option) by remote-control command. Selections include for example --parameters: R and Q, L and Q, C and D; equivalent circuit: series or parallel; test rate: SLOW, MEDIUM, or FAST; frequency: 100 Hz, 120 Hz, 1 kHz, and 10 kHz; and averaging: 1 or 10 measurements; etc.

The instrument normally autoranges to find the correct range; but operation can be restricted to any of the four ranges (1, 2, 3, 4), under keyboard control. Each range is 4 octaves wide (16:1), with reduced-accuracy extensions both above and below.

Leading zeroes before the decimal point are blanked out of the RLC and QD displays.

#### 4.1.3 Block Diagram.

Figure 4-1.

The block diagram shows the microprocessor in the upper center connected by data and address buses to digital circuitry including memories (RAM and ROM) and peripheral interface adaptors (PLAs).

Analog circuitry is shown in the lower part of the diagram, where  $Z_x$  is supplied with a test signal at frequency  $f$  from a sine-wave generator, driven by a crystal-controlled digital frequency divider circuit. The P/I signal selector and instrumentation amplifier supply an analog signal that represents 2 impedances alternately: the appropriate internal resistance standard,  $R_s$ , and the DUT,  $Z_x$ .

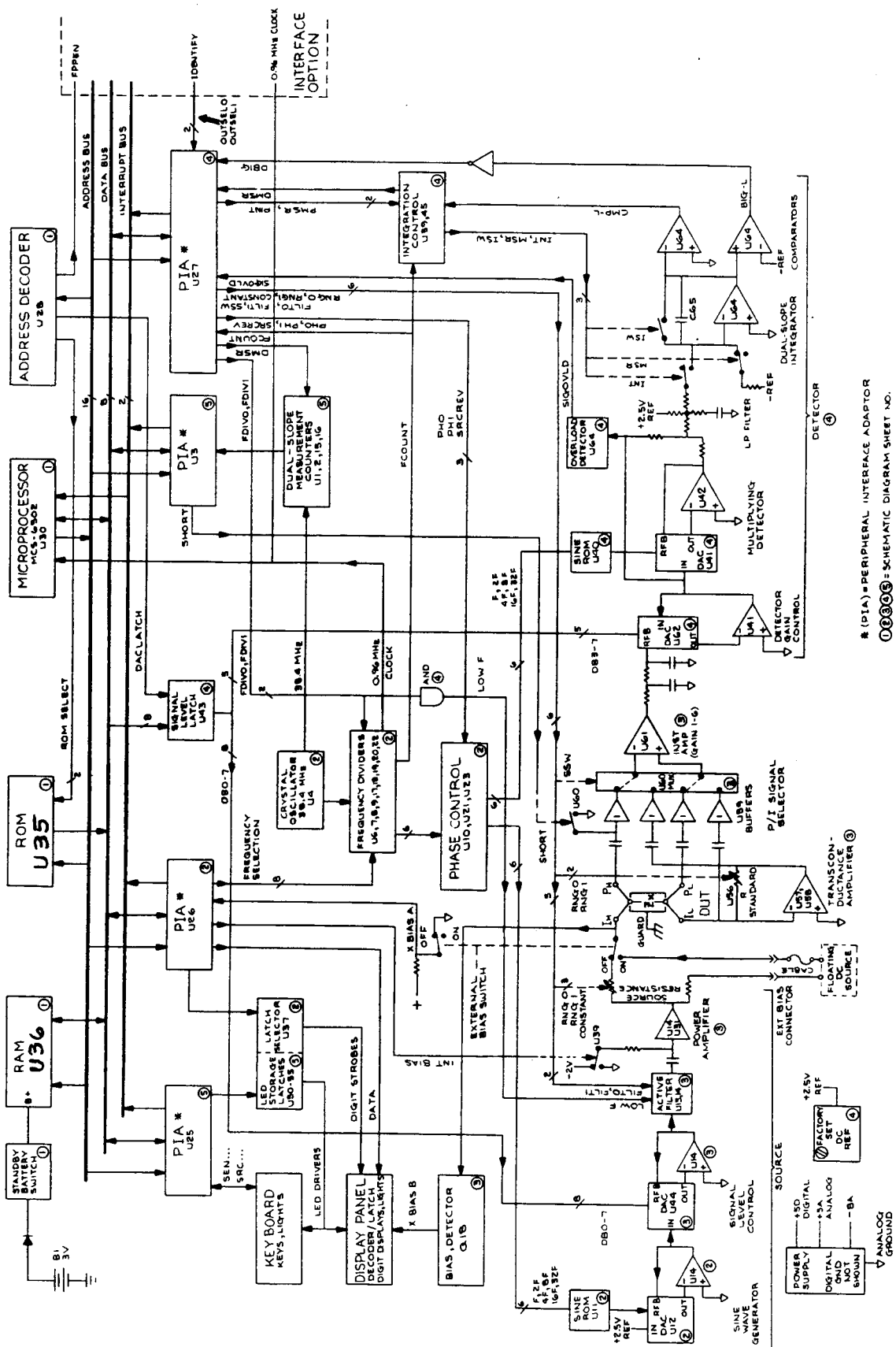

Figure 4-1. Block diagram of the 1659 RLC DigiBridge.

The phase-sensitive (dual-slope) detector and measurement counters convert this analog signal into digital form. See circuit descriptions below.

From this information and criteria selected by the keyboard (or remote control), the microprocessor calculates the RLC and QD values for display, averaging, bin assignments, etc.

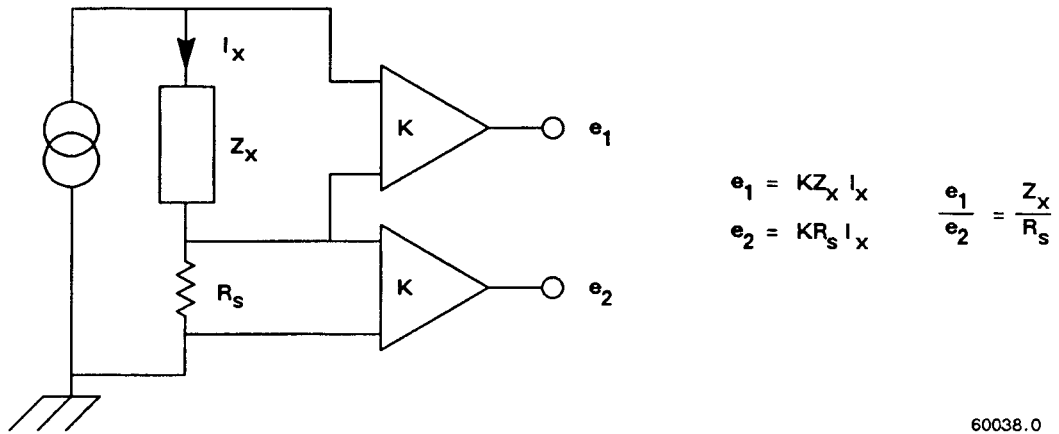

Figure 4-2. Elementary measurement circuit.

## 4.2 PRINCIPAL FUNCTIONS.

### 4.2.1 Elementary Measurement Circuit.

Figure 4-2.

The measurement technique is illustrated by the accompanying simplified diagram, which can be correlated with the previous (block) diagram. A sine-wave generator drives current  $I_x$  through the DUT  $Z_x$  and standard resistor  $R_s$  in series. Two differential amplifiers with the same gain  $K$  produce voltages  $e_1$  and  $e_2$ . Simple algebra, some of which is shown in the figure, leads to the expression for the "unknown" impedance:

$$Z_x = R_s [e(1)/e(2)]$$

Notice that this ratio is complex. Two values (such as C and D or Land Q) are automatically calculated by the microprocessor from  $Z_x$ , frequency, and other information.

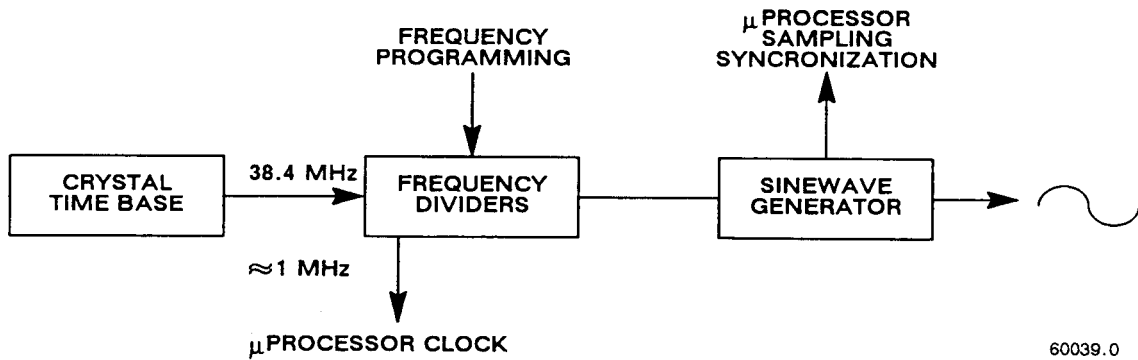

60039.0

Figure 4-3. Frequency and timing source. Several clocks and synchronizing pulses as well as the measurement signal are derived from the accurate time-base signal.

4.2.2 Frequency and Time Source.

Figure 4-3.

A necessary standard for accuracy is the frequency of the test signal; and equally important are the generation of multi-phase references for detection and clocks for the microprocessor. Frequency and timing requirements are implemented by derivation from a single very accurate oscillator, operating at 38.4 MHz. Digital dividers and logic circuitry provide the many clocks and triggers, as well as driving the sine-wave generator described below.

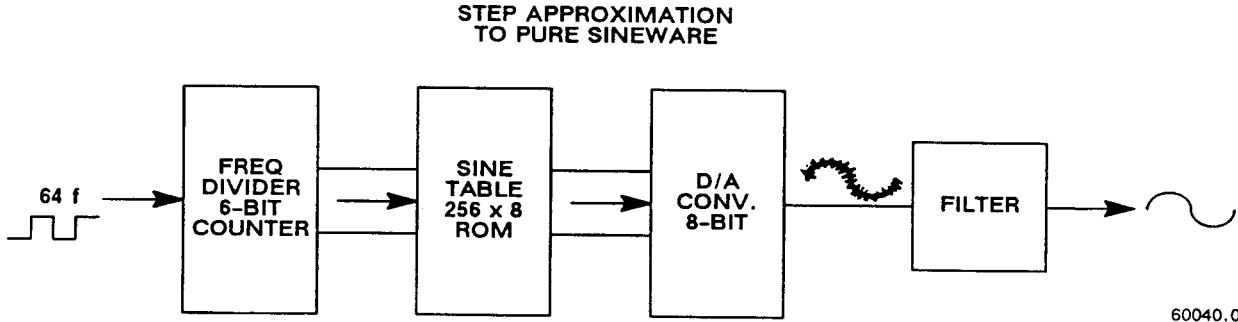

60040.0

Figure 4-4. Sine wave generator. Given square waves at frequencies of 64 f, 32 f, 16 f, 8 f, 4 f, 2 f, and f, a ROM containing the mathematical sine function drives a D / A converter to form a finely stepped approximation to a sine wave at frequency f. The filter provides smoothing of the test signal.

### 4.2.3 Sine- Wave Generation.

**Figure 4-4.**

*Source of the Test Signal.* Starting with a digital signal at 64 times the selected test frequency, the sine wave generator provides the test signal that drives a small but essential current through the DUT, The sine wave is generated as follows,

Binary dividers count down from 64 f, providing signals at 32 f, 16 f, " 2f, f, This set of signals is used to address a read-only memory which contains a 64-step approximation to a sine function, The ROM output (as an 8-bit binary number) is converted by a D / A converter to a stepped approximation of a sine-wave, which is then smoothed by filtering before its use in the measurement of a DUT, The filter is switched appropriately, according to the selected test frequency,

*Source of the Reference Sine Wave for the Multiplying Detector,* Another sine-function ROM is addressed by the same digital signals (64 f through f) to produce another stepped approximation of a sine wave at 0 degrees, Suitable inversions of signals 2f and/or f serve to shift the phase of the output sine wave, under microprocessor control, by 90, 180, or 270 degrees,

### 4.2.4 The Dual Slope Integrating Detector and Converter

(See Figure 4-1.)

*Circuitry,* The phase-sensitive detector/converter circuit consists of a multiplier whose dc output is measured by a dual-slope converter, providing the measurement in digital form, The multiplier is a multiplying D / A converter whose "reference" input is the test signal and whose digital controls are signals representing a stepwise approximation of a reference sine wave at the test frequency, The dc value of the multiplier output is proportional to the product of signal magnitude multiplied by the cosine of the phase angle between the test signal and the reference sine wave,

The dual-slope converter includes these three stages: dual-slope integrator, comparator, and counter (all controlled by the microprocessor through PIAs), In the dual-slope integrator, a capacitor is charged for a controlled integration time interval (sampling) at a rate proportional to the multiplier output voltage, This capacitor is then discharged at a fixed rate (the deintegration slope) to zero voltage, a condition that is sensed by a comparator, (See signal name "CMP-L" on the block diagram,) Thus, the integrator and comparator transform the sampled dc output from the multiplier into a precise interval of time, The dual-slope measurement counter is gated by this time interval, thus converting it into a digital number, which is a principal data input to the microprocessor,

If the integration time is relatively long, so that the integration capacitor voltage reaches a certain reference level, another comparator triggers the beginning of the return (deintegration) slope before sampling has been completed, (See signal name "BIG-L" on block diagram,) The detector is then sampling and converting simultaneously for a portion of the dual-slope conversion cycle,

*Data Acquisition Time,* Data acquisition time includes pauses for synchronization, and several integration/ deintegration cycles, Data acquisition time is a complex, discontinuous function of test frequency, the selected measurement rate, and pauses for synchronization,



---

# Service – Section 5

---

5.1	CUSTOMER SERVICE . . . . .	5-3
5.2	INSTRUMENT RETURN . . . . .	5-3
5.3	REPAIR AND REPLACEMENT OF CIRCUIT BOARDS . . . . .	5-3
5.4	PERFORMANCE VERIFICATION . . . . .	5-3
5.5	DISASSEMBLY AND ACCESS . . . . .	5-8
5.6	PERIODIC MAINTENANCE . . . . .	5-18
5.7	TROUBLE ANALYSIS . . . . .	5-20
5.8	ACCURACY VERIFICATION . . . . .	5-30
5.9	RECALIBRATION . . . . .	5-43
5.10	INTERNAL SETTINGS . . . . .	5-51

## WARNING

These servicing instructions are for use by qualified personnel only. To avoid electrical shock, do not perform any servicing, other than that contained in the operating instructions, unless you are qualified to do so.

## CAUTION

For continued protection against fire hazard, replace fuse only with same type and rating as shown on rear panel and in parts list.

Service personnel, observe the following precautions whenever you handle a circuit board or integrated circuit in this instrument.

**HANDLING PRECAUTIONS  
FOR ELECTRONIC DEVICES  
SUBJECT TO DAMAGE BY STATIC ELECTRICITY**

Place instrument or system component to be serviced, spare parts in conductive (anti-static) envelopes or carriers, hand tools, etc., on a work surface defined as follows. The work surface, typically a bench top, must be conductive and reliably connected to earth ground through a safety resistance of approximately 250 kilohms to 500 kilohms. Also, for personnel safety, the surface must NOT be metal. (A resistivity of 30 to 300 kilohms per square is suggested.) Avoid placing tools or electrical parts on insulators, such as books, paper, rubber pads, plastic bags, or trays.

Ground the frame of any line-powered equipment, test instruments, lamps, drills, soldering irons, etc., directly to earth ground. Accordingly, (to avoid shorting out the safety resistance) be sure that grounded equipment has rubber feet or other means of insulation from the work surface. The instrument or system component being serviced should be similarly insulated while grounded through the power-cord ground wire, but must be connected to the work surface before, during, and after any disassembly or other procedure in which the line cord is disconnected.

Exclude any hand tools and other items that can generate a static charge. (Examples of forbidden items are non-conductive plunger-type solder suckers and rolls of tape.)

Ground yourself reliably, through a resistance, to the work surface; use, for example, a conductive strap or cable with a wrist cuff. The cuff must make electrical contact directly with your skin; do NOT wear it over clothing. (Resistance between skin contact and work surface through a commercially available personnel grounding device is typically in the range of 250 kilohms to 1 megohm.

If any circuit boards or IC packages are to be stored or transported, enclose them in conductive envelopes and/or carriers. Remove the items from such envelopes only with the above precautions; handle IC packages without touching the contact pins.

Avoid circumstances that are likely to produce static charges, such as wearing clothes of synthetic material, sitting on a plastic-covered or rubber-footed stool (particularly while wearing wool), combing your hair, or making extensive erasures. These circumstances are most significant when the air is dry .

When testing static-sensitive devices, be sure dc power is on before, during, and after application of test signals. Be sure all pertinent voltages have been switched off while boards or components are removed or inserted, whether hard wired or plugged in.

The symbol shown below may appear on circuit boards and/or schematic diagrams to call attention to static sensitive component parts. However, the absence of such a symbol does NOT assure the absence of static sensitive devices.



**CERTIFICATION**

Products provided by GenRad are thoroughly tested and calibrated to meet product specifications. A Record of Certification of conformance (which certifies that the product meets its specifications and that its calibration is traceable to appropriate national standards) is available upon request at the time of purchase. GenRad recommends that this product be recalibrated and certified annually. (Refer to Paragraph 5.9)

## 5.1 CUSTOMER SERVICE

Our warranty (at the front of this manual) attests the quality of materials and workmanship in our products. If malfunction does occur, our service engineers are available for technical telephone assistance. If the difficulty cannot be eliminated by use of the following service instructions, please contact QuadTech's Technical Assistance Center (see last page of this manual), giving full information of the trouble and of steps taken to remedy it. Describe the instrument by name, catalog number, serial number. (Refer to Digibridge rear panel.)

## 5.2 INSTRUMENT RETURN

### 5.2.1 Return Material

Before returning an instrument to QuadTech for service, contact our nearest Service and Logistics Center for return shipping instructions (see last page).

### 5.2.2 Packaging

To safeguard your instrument during storage and shipment, please use packaging that is adequate to protect it from damage, i.e., equivalent to the original packaging. Any QuadTech field office can advise. Contract packaging companies in many cities can provide dependable custom packaging on short notice. Mark the box "DELICATE INSTRUMENT".

## 5.3 REPAIR AND REPLACEMENT OF CIRCUIT BOARDS

This instruction manual contains sufficient information to guide an experienced and skillful electronic technician in fault analysis and the repair of some circuits in this instrument. Contact QuadTech's Technical Assistance Center if additional help is needed. (See last page.) Customers in the U.S.A are also invited to use the following telephone numbers: **Sales & Service: 800-253-1230, Technical Assistance: 978-461-2100.**

SALES	800-443-6723	or:	800-4-GENRAD
TECHNICAL ASSISTANCE CENTER			508-371-1203
SERVICE			508-369-4400

## 5.4 PERFORMANCE VERIFICATION

### 5.4.1 General

This procedure is recommended for verification that the Digibridge tester is performing normally. No other check is generally necessary because this procedure checks operation of nearly all of the circuitry. If the Digibridge passes this performance verification, it is safe to assume that the instrument is functional. (However, to insure *accuracy*, refer to paragraph 5.8, Accuracy Verification.)

All tests are done at 1 kHz, and in SLOW measure rate so that basic bridge accuracy is realized. The accuracy of each verification is therefore  $\pm 0.1\%$  plus the tolerance of the verifying DUT, which is discussed below. Table 5-1 lists the necessary resistors, capacitors, and inductors, which are inexpensive and readily obtained. The most accurate ones available should be used; tolerances listed are the "best" commonly catalogued. There are no calibrations and only one adjustment that could require resetting; and the internal standards are very stable. This procedure checks at least one point on each of the four measurement ranges.

**Table 5-1  
COMPONENTS RECOMMENDED FOR PERFORMANCE VERIFICATION**

Component	Type *	Nominal Value	Tolerance
Resistors Metal Film	MIL-R-10509C (Style RN60)	49.9 ohms	+/- 0.1%
		499 ohms	+/- 0.1%
		4.99 kilohms	+/- 0.1%
		49.9 kilohms	+/- 0.1%
		499 kilohms	+/- 0.1%
Capacitors Metalized	Polyester GE: BA-19A106C Polystyrene Southern: 1PJ-334J Electronics 1PJ-333J Corp. 1PJ-332J	10 uF	+/- 5%
		0.33 uF	+/- 0.5%
		0.033 uF	+/- 0.5%
		0.0033 uF	+/- 0.5%
Inductors	J.W.Miller		
		Non-Ferrous 9220-28	1000 uH +/- 5%
		Ferrite Core 9250-107	100 mH +/- 10%

-----  
\* Equivalentents may be substituted

**CAUTION**

Be sure that the voltage switch, rear panel, is correctly set for your power line (90 to 125 V -or- 180 to 250 V), that no components are connected to the test fixture, and that the EXTERNAL BIAS switch is OFF.

**5.4.2 Performance Verification Procedure**

a. After the line voltage switch has been set to correspond to the input line voltage, connect the line cord and switch the POWER ON.

The Digibridge then enters an automatic self-check routine and displays a sequence of codes. If one of these displays persists, a check failure has occurred and further checks or measurement are inhibited. (See para 3.13.)

Normally, upon completion of the power-up self check, the following preset or default conditions are established, lighting a vertical line of indicators. (However, if the keyboard is locked, the locked-in conditions are re-established and most of the keyboard indicators are dark.)

Normal:  
 [FUNCTION] -- MEASURE  
 [DISPLAY] -- VALUE  
 [MEASURE RATE] -- SLOW  
 [MODE] -- CONT\*  
 [EQUIVALENT CIRCUIT] -- SERIES

\* NOTE: If interface is installed, MODE now indicates TRIGGERED and display is blank.

The main panel displays and indicators (RLC and QD) will normally come up with random, meaningless readings; ignore them.

b. However, if the keyboard is locked and the MEASURE indicator is lit, to unlock it, press:

[1][6][5] [9] [=] [LOCK]

(If you have the interface option (1658-9620, it is possible that the FUNCTION is locked at ENTER. Then the use of remote control signals is required either to unlock the keyboard or to select the MEASURE function, which is a prerequisite for unlocking from the keyboard).

c. Confirm or select the following measurement conditions on the Digibridge:

[FUNCTION]	-- ENTER (necessary for determining test frequency)
[DISPLAY]	-- VALUE
[MEASURE RATE]	-- SLOW
[MODE]	-- TRIGGERED (necessary for zeroing)
[EQUIVALENT CIRCUIT]	-- SERIES
EXTERNAL BIAS	-- OFF (slide switch)

d. Verify that the test frequency is 1 kHz (the power-up default), the 1 kHz indicator (right-side of display panel) should be lit. If any other reading is observed, press: [SHIFT][FREQUENCY] key until the 1 kHz indicator is lit.

e. Press the [FUNCTION] key to select MEASURE function.

f. If the Digibridge has an interface option (which has two 24-pin interface connectors on the rear panel), be sure that the TALK switch (rear panel) is set to TALK ONLY.

g. Zero the Digibridge as follows, before making measurements. (Make sure that the MEASURE and TRIGGERED keyboard indicators are lit.)

*Test Fixture ---for the 1659 Digibridge.* Install the axial-lead adaptors in the test fixture in position for accepting the largest of the verifying DUTs in Table 5-1.

*Open Circuit Zero.*

Press the [C/D] key.

Press: [1][6][5][9][=][SHIFT][OPEN].

Keep hands and all objects at least 10 cm (4 in.) from fixture contacts.

Press START to initialize zeroing operation.

Wait until the GO indicator lights.

*Short Circuit Zero.* Short the fixture with a piece of copper wire, pressed into the test-fixture adaptors, where the DUT leads will go. Do not move the test fixture adaptors.

Press [1][6] [5] [9] [=] [SHIFT] [SHORT].

Press START to initialize zeroing operation.

Wait until the GO indicator lights again.

NOTE: For maximum accuracy, this zeroing procedure should be performed at the start of each day and every time the fixture configuration is changed.

h. Press the [MODE] key to select CONT. (continuous measurements).

i. Press [R/Q].

j. Insert, as DUT, the first resistor specified in Table 5-2.

k. Verify that the displays are within the extremes shown for check number 1 in Table 5-2, if the resistor is within the tolerance listed in Table 5-1.

*NOTE ON TOLERANCES:* Acceptable performance of the instrument is bracketed by the set of display "extremes" in Table 5-2. These are defined as the nominal (ideal) measurements plus-or-minus the sum of the instrument accuracy tolerances and the DUT accuracy tolerance (or slightly more). If the accuracy of your DUT is different from the recommendation, revise the acceptable "extremes" accordingly. Notice that this performance verification is NOT intended to prove the accuracy of the instrument.

*NOTE ON INSIGNIFICANT FIGURES:* The right-hand digit(s) of the display may be expected to flicker and change (with the automatically repeating measurements) if they are not significant for the specified accuracy of the instrument. (See further comment with step p below.)

l. Similarly, make the other checks indicated in Table 5-2, under the R/Q parameter (checks 2, 3, 4, 5).

m. Press [C/D].

n. Insert as DUT the first capacitor specified in Table 5-2 (check number 6).

o. Verify that the displays are within the extremes shown for check number 6 in Table 5-2, if the capacitor is within the tolerance listed in Table 5-1.

p. Similarly make the other checks indicated in Table 5-2 under the C/D parameter (checks 6,7,8,9).

In check number 8, verify that the fifth digit is reasonably stable, as follows. (Notice that the fourth digit is the last significant one in the readout, for 0.02 percent accuracy.) In check number 8, the flickering of the fifth digit should stay typically between 2 counts. For example, if the display is 330.1X nF, the 'X' might flicker between 2 and 4. If, for example, .X" is flickering between 9 and 11, it will of course cause a flickering of the preceding digit (330.19 and 330.21). In such a case, the correct readout is the larger 4-digit number (330.2) and the fifth digit is acceptably stable.

q. Press [L/Q].

r. Insert as DUT the first inductor specified in Table 5-2 (check number 10).

s. Verify that the displays are within the extremes shown for check number 10 in Table 5-2, if the inductor is within the tolerance specified by Table 5-1.

t. Similarly check the inductor specified in check number 11.

**Table 5-2  
PERFORMANCE VERIFICATION**

Check Number	Parameter	DUT	RLC Display Extremes	QD Display Extremes
1	R/Q	49.9 ohms	48.800 to 50.000 ohms	*
2		499 ohms	488.00 to 500.00 ohms	
3		4.99 kilohms	4.8800 to 5.0000 kohms	
4		49.9 kilohms	48.800 to 50.000 kohms	*
5		499 kilohms	488.00 to 500.00 kohms	
6	C/D	0.0033 uF	3280.2 to 3319.8 pF	.0000 to .0100
7		0.033 uF	32.802 to 33.198 nF	.0000 to .0100
8		0.33 uF	328.02 to 331.98 nF	.0000 to .0100
9		10 uF	9.490 to 10.510 uF	.0000 to .0300
10	L/Q	1000 uH	.9490 to 1.0510 mH	*
11		100 mH	89.90 to 110.10 mH	*

\* The right hand display (QD) can be expected to change frequently; accuracy of that display is not significant in these performance checks.

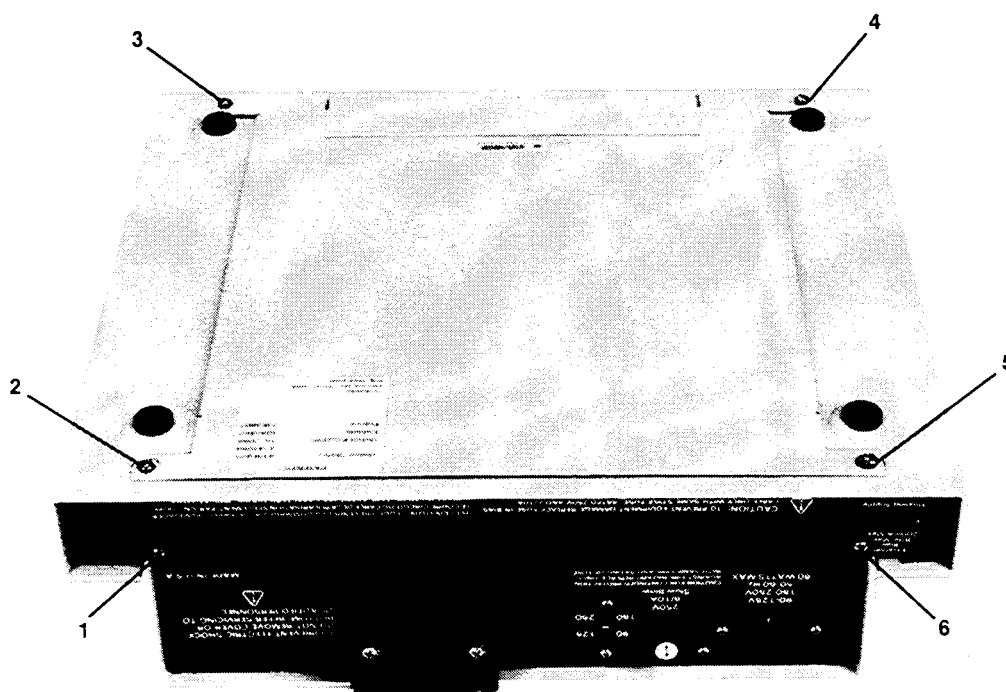

Figure 5-1. Rear and bottom view of the 1659 Digibridge, showing screw locations for disassembly: top-cover screws 1 and 6; bottom-shell screws 2, 3, 4, 5.

## 5.5 DISASSEMBLY AND ACCESS

### WARNING

If disassembly or servicing is necessary, it should be performed only by qualified personnel familiar with the electrical shock hazards inherent to the high-voltage circuits inside the cabinet. Be sure that you never short or apply voltage to the battery Bl. (See paragraph 5.7.3.)

### CAUTION

Observe precautions against damage by static electricity whenever you handle a circuit board or integrated circuit in this instrument. Refer to the beginning of Section 5.

#### 5.5.1 Disassembly of 1659 Digibridge

#### Figures 5-1 through 5-9.

Use the following procedure for access to replaceable parts and contact points used in trouble analysis.

a. Disconnect the power cord.

b. Remove the top-cover screws from the rear panel of the main chassis. See Figure 5-1. (These screws are slightly outboard from the ones designated for interface option or cover plate. One of them is just to the right of the label EXTERNAL BIAS.) Slide the top cover forward about 6mm so that its front corners are unhooked. Lift it directly upward (Figure 5-2). Reassembly note: Install the cover without air filter, using the 2 screws, 13 mm long. Then stuff the air filter into position through the air intake opening; using your fingers, press the edges and corners of the filter into position.



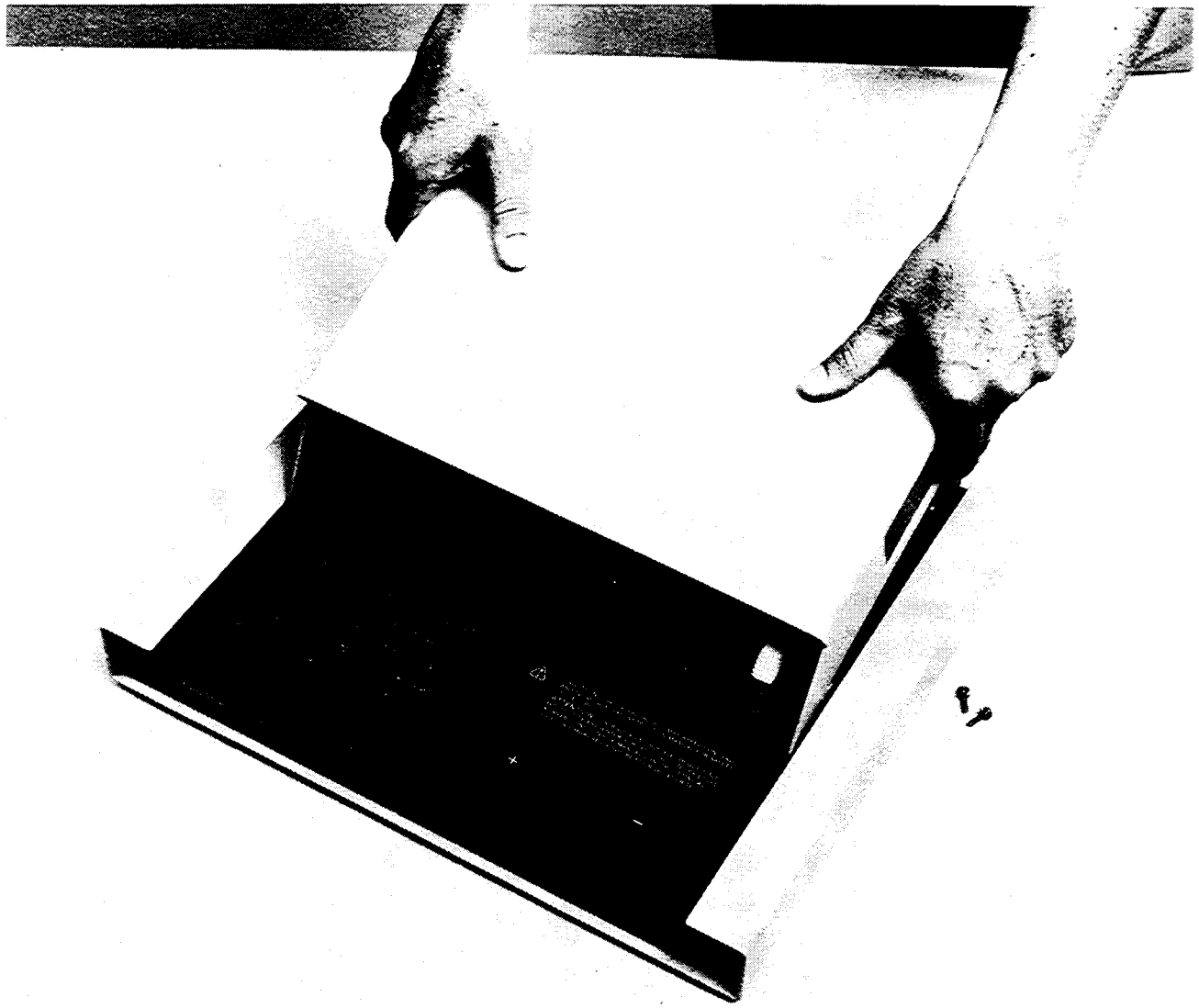

Figure 5-2. Removal of the top cover from a Digibridge.

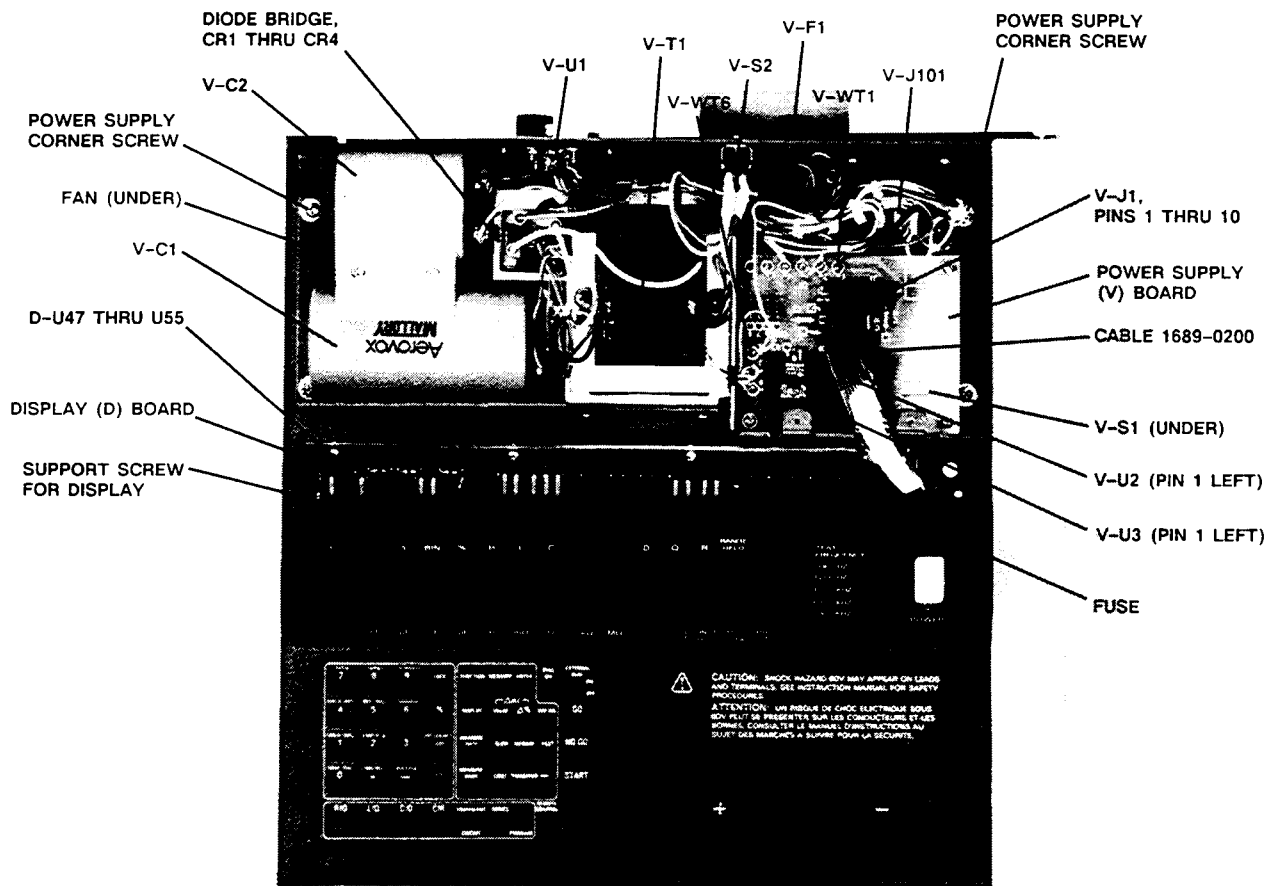

Figure 5-3. Power Supply (V assembly) and display (or DB) board, shown in the Digibridge, with top cover off. The protective cover has been removed from above the power supply assembly.

c. Remove the interface option, if you have one, after removing the 2 large screws with resilient washers in the rear panel. See Figure 1-2. (If the panel held by these screws is blank, leave it in place.) Reassembly note: Align board edges carefully with connector and guide that are inside of instrument, while pushing interface option into position.

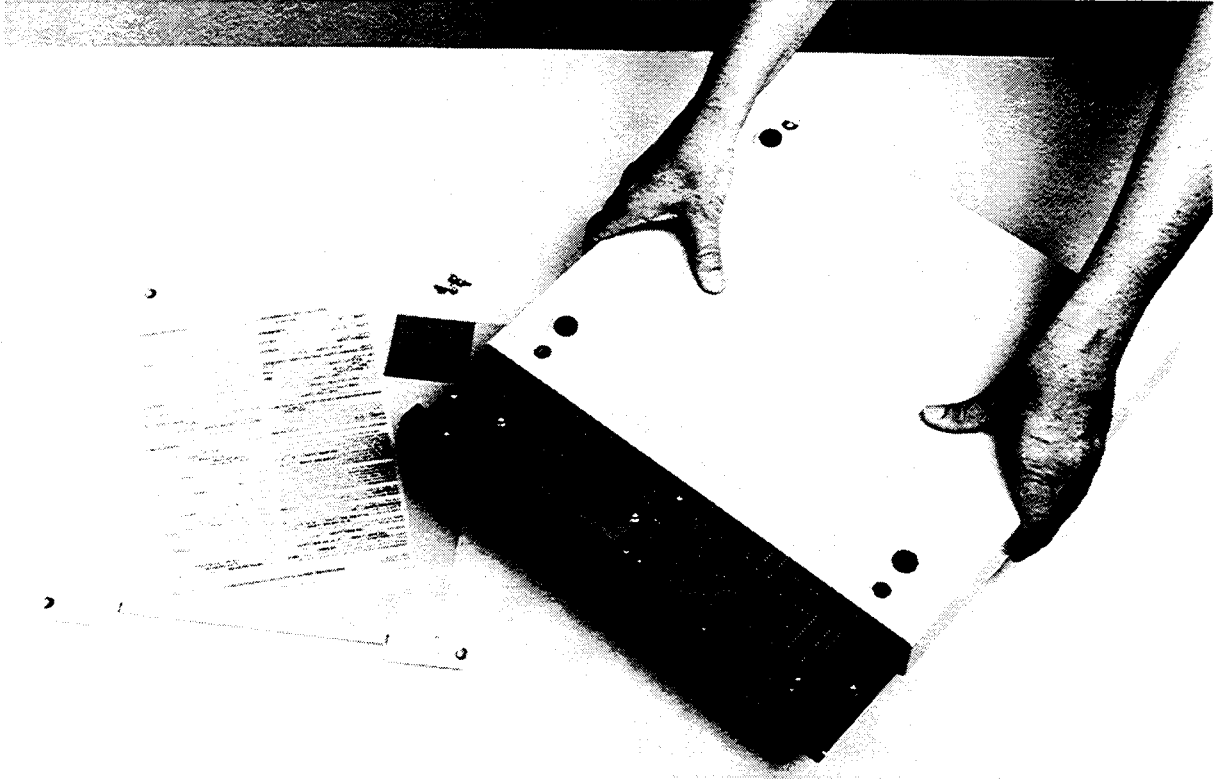

Figure 5-4. Removal of the bottom shell from the Digibridge.  
Notice that the top cover has been temporarily installed as a support.

d. Remove 4 screws from the bottom shell, one near each rubber foot (Figure 5-1). Lift the instruction card and its retaining pan free. Slide the bottom shell back (or forward), free of the main chassis (Figure 5-4). Reassembly notes: Be sure to enfold the pliable dirt seals at left and right sides of main chassis as you start to slide bottom shell onto main chassis; use 4 screws, 8 mm long.

#### NOTE

It may be advisable to provide "upside-down" support by reinstalling the top cover temporarily.

The next step, removal of display board, is recommended before removal of the main circuit board.

e. Remove the 2 screws and washers (Figure 5-7, 2 screws at location D) from the bottom of the main board that hold the display board brackets.

f. Pull the board directly out of its socket in the main board. Keep the display board in its original (inclined) plane until it is completely free (Figure 5-5). Reassembly note: 2 screws, 6 mm long with washers.

g. Disconnect the ribbon cable (1689-0200) from main board (at connector J5). The cable can be removed from the power supply (J1) after removal of the protective cover as described below. Notice that the connectors are symmetrical; reversing either or both is permitted; and the cable is extra long, for convenience in servicing.

NOTE: The next two steps, removal of the power supply, are NOT related to the removal of the main board. Either can be left in place while the other is removed.

### WARNING

Dangerous voltages are present on wires and terminals that will be exposed in the following steps. BE SURE THAT THE POWER CORD IS DISCONNECTED BEFORE PROCEEDING.

h. Remove the protective cover (with warning label) from upper right portion of power supply (3 screws).

### CAUTION

In reassembling, inspect carefully to be sure that none of the nearby wires touches the fan rotor or blades. Inspect by looking under the 1657-4720 board. To verify free rotation, blow on the fan and watch it spin.

i. Remove the five screws that fasten the bottom of the power supply to the main chassis. Four screws are at corners of power supply; the fifth is nearly hidden, between the transformer and the largest capacitor. Lift the power supply slightly and move it back carefully while disengaging the POWER pushbutton extension from its hole in the front panel (Figure 5-6). Reassembly note: 5 screws, 8 mm long.

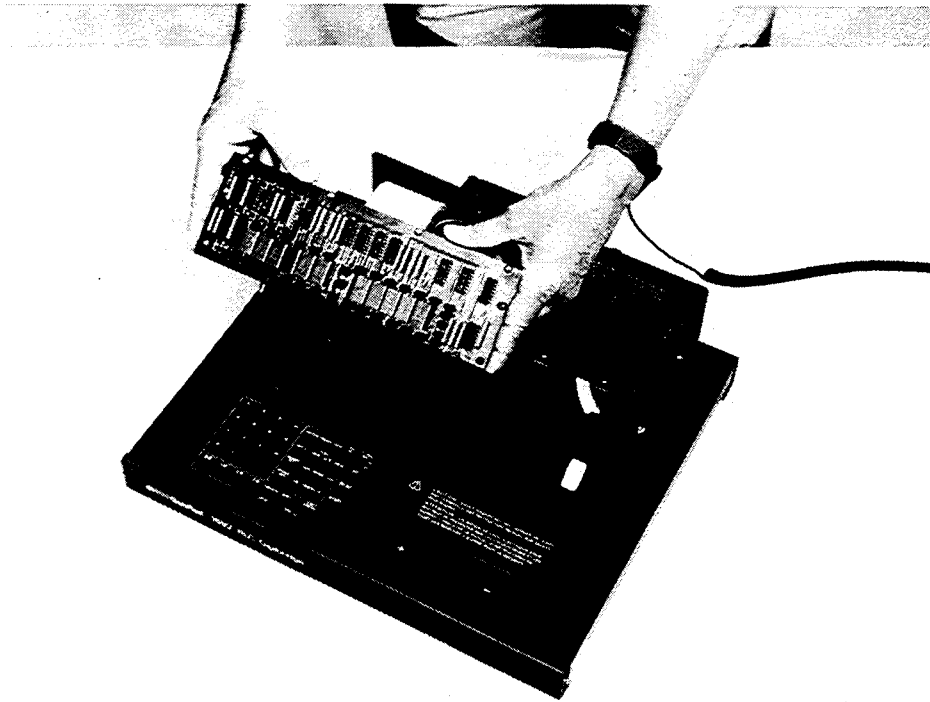

Figure 5-5. Removal of the display board from a Digibridge.

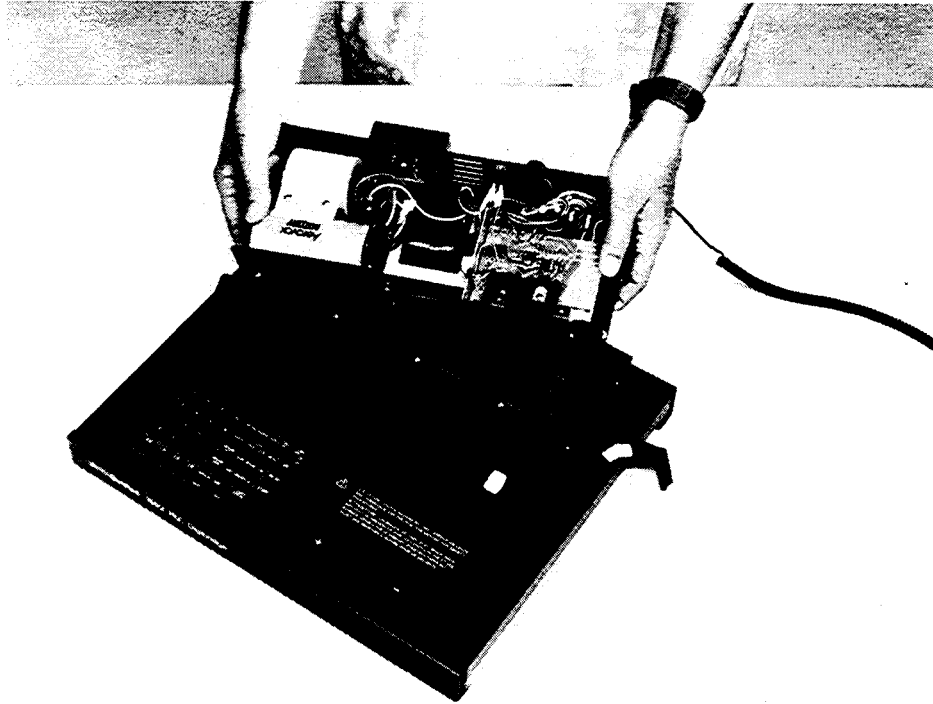

Figure 5-6. Removal of the power supply from a Digibridge.

The ribbon cable must be disconnected first.

The display board can be removed first or left in place, as shown here.

Before removing the main board, the ribbon cable must be disconnected first. Prior removal of the display board also is highly recommended. Because the board is partially enclosed by the main chassis, unusual care may be needed in removal. These motions are suggested: slide toward the rear, tilt as shown, and gently lift free.

j. Remove 11 screws from positions shown in Figure 5-7 as A and B, to free the main board. Lift slightly, and slide the board rearward so the keyboard can be lifted past the lip of the chassis. Tilt the front edge up about 6 cm (2 in.) before lifting the whole board out. Figure 5-8 shows how to tilt the main board to the best position for removal. Reassembly note: return washers to original positions; screws at A are 6 mm long, B screws are 8 mm long.

k. To remove the keyboard module, remove the 4 screws at E (Figure 5-7) and carefully pull the module directly away from the main board. Reassembly note: be very careful not to bend pins when plugging the keyboard-module connectors into their main-board sockets; use 4 screws, 6 mm long.

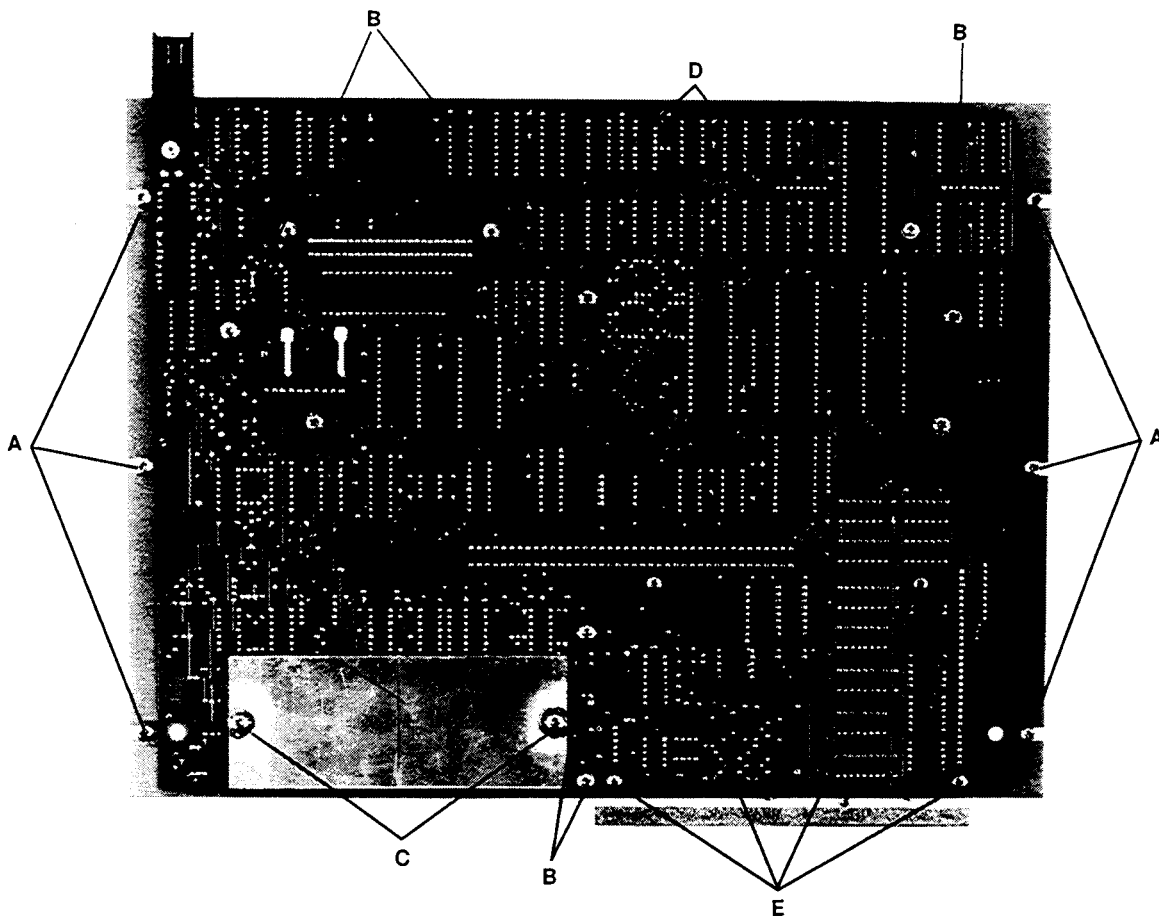

Figure 5-7. Locations of screws on the main board of the 1659 Digibridge, bottom view.  
 Screws at A and B hold the board to the chassis.  
 Screws at C hold a shield and (with 2 screws from the other side) the test fixture assembly.  
 Screws at D hold brackets for the display board; and at E, the keyboard module.

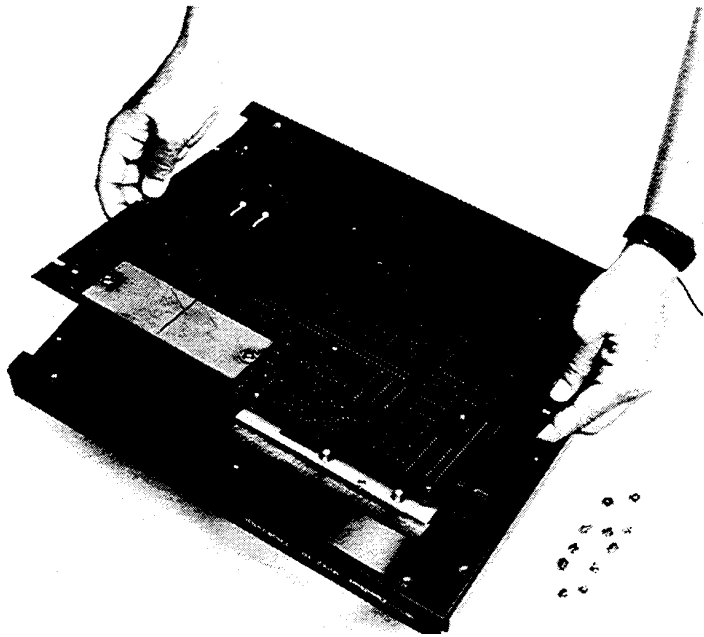

Figure 5-8. Removal of the main board from a Digibridge.

1. For access to the test-fixture contacts, remove the dross tray 1657-7700 (the plastic dirt catcher) by spreading it slightly and lifting it off. Then remove the guide block assembly 1689-2000 (includes dross tray) by removing 2 screws and associated washers, spacers and shield plate, on bottom of main board (see "C", Figure 5-7) and 2 test-fixture center shield screws (use hexagonal wrench 2.38 mm = .094 in.) from top of the main board. (See also Figure 5-9.)

Reassembly note: C screws are 13 mm long. Position the guide lock assembly for smooth entry of a radial lead DUT before tightening screws. If an extension cable is available, its paddle boards can be used for a centering jig. Otherwise verify by eye, looking directly down on the board, through the slots in the guide block, to the contact gaps.

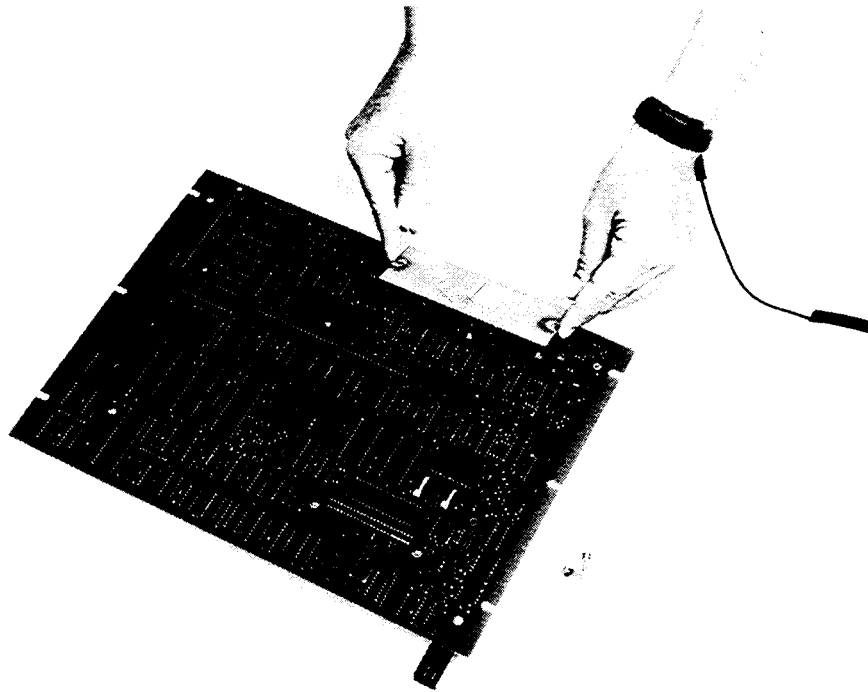

Figure 5-9. Removal of the shield from below the test fixture of the 1659 Digibridge. Notice the use of a personnel grounding strap.

### 5.5.2 Access

*Main Board.* Locations of principal components for trouble analysis are shown in Section 6 layout diagram (Figure 6-4). The analog circuitry is placed along the front (forward of the display board connector) and along the front half of the right-hand edge. However, most of this board supports digital circuitry.

*Power Supply.* For access to parts in the power supply, refer to Section 6.

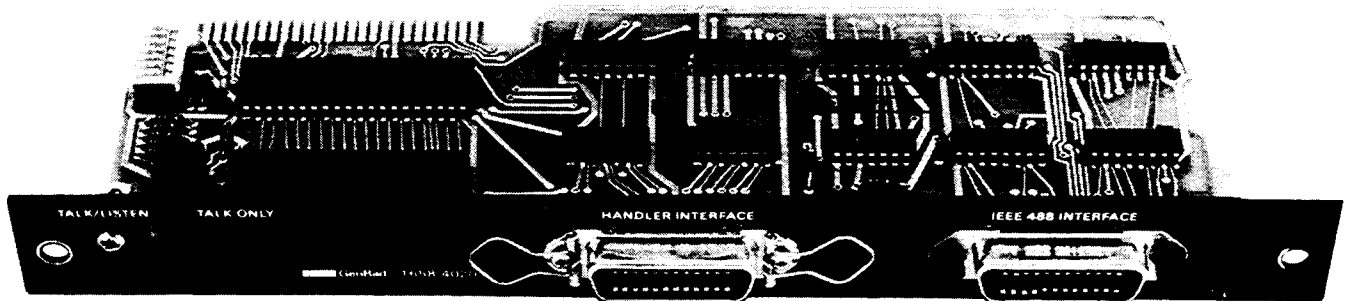

Figure 5-10. IEEE/handler interface option assembly 1658-9620, including the interface option board (IOB) 1658-4620.



### 5.5.3 IEEE/Handler Interface Options

**Figure 5-10.**

This Digibridge accepts the 1658-9620 option that provides both IEEE-488-bus and handler interfaces. Refer to the Specifications in the front of this manual and to Table 1-3 in Section 1.

*Removal of Interface Board.* The procedure is as follows:

- a. Switch POWER OFF and disconnect power cord from Digibridge.
- b. Place the instrument in the normal position (flat on table or in rack). Looking at the rear panel, remove the two screws that hold the interface-option's rear panel (or the blank cover plate) from the Digibridge. Refer to Figures 1-3 and 1-4, in Section 1.
- c. Withdraw the interface option (or the cover plate) horizontally, directly away from the front panel.

#### CAUTION

Observe precautions while handling the interface option, because there are staticsensitive parts on the board. **DO NOT TOUCH THE CIRCUITS** or ICs. Refer to Section 5 of this manual, for recommended handling procedure.

*Installation.* Install or reinstall the interface option as follows.

- a. Hold the interface option by its rear panel, so that the labels near the connectors read "right-side up". *Look through the opening into the instrument and observe the connector that will receive the interface option board's edge contacts.* Insert the board *horizontally* through the opening, with care to align the board-edge contacts with the mating connector inside.
- b. Press the interface option fully into the Digibridge by hand, confirming that alignment is correct. Reinstall the screws that were removed in step b, above.

### 5.5.4 Removal of Multiple-Pin Packages

Use caution when removing a plug-in integrated-circuit or other multiple-pin part, not to bend pins nor stress the circuit board. Withdraw the part straight away from the board. Unless an IC is known NOT to be a staticsensitive type, place it immediately on a conductive pad (pins in the pad) or into a conductive envelope.

DO NOT attempt to remove a soldered-in IC package unless you have the proper equipment and skills to do so without damage.

## 5.6 PERIODIC MAINTENANCE

### 5.6.1 Care of the Test Fixture

For best results and minimum maintenance effort, the operator must remove any obvious dirt from leads of DUTs before inserting them into the test fixture. Its contacts will wipe through a film of wax, but they can become clogged and ineffectual if the operator is careless about cleanliness.

About once a year (more or less depending on usage) the test fixture and its axial-lead adaptors should be inspected and cleaned as follows:

- a. Clean the contact surfaces and blades of the axial-lead adaptors with isopropyl alcohol. Rub with a cotton swab (Q-tip). Remove any remaining liquid alcohol by blowing with the breath and remove any remaining cotton fibers, with tweezers.
- b. Expose the test-fixture contacts for cleaning as follows (depending on which test fixture is being cleaned).

#### **Test Fixture Included On 1659 Digibridge.**

Remove the MB board and expose the test-fixture contacts by removing its guide block assembly (part number 1689-2000), as described in paragraph 5.5.1 and repeated here for convenience.

Remove the dross tray 1657-7700 (the plastic dirt catcher) by spreading it slightly and lifting it off.

Carefully remove the guide block assembly (part no. 1689-2000, includes dross tray) by removing 2 screws and associated washers, spacers and shield plate, on bottom of main board (see "C", Figure 5-7) *and* 2 test-fixture center shield screws (use hexagonal wrench 2.38 mm = .094 in.) from top of the main board. (See also Figure 5-9.)

Reassembly note: C screws are 13 mm long. Position the guide block assembly for smooth entry of a radial-lead DUT before tightening screws. If an extension cable is available, its paddle boards can be used for a centering jig. Otherwise verify by eye, looking directly down on the board, through the slots in the guide block, to the contact gaps.

#### **1689-9600 Test Fixture (the one without a START bar).**

Remove the four rubber feet (one screw apiece) and slide the bottom housing off.

Remove the two hex socket head screws near the middle of the circuit board (top side; use hexagonal wrench 2.38 mm = .094 in).

Remove the two screws and associated washers near the right and left ends of the circuit board (bottom side).

Carefully remove the guide block assembly (part number 1689-2000).

Reassembly note: See above.

### **1689-9605 Test Fixture (the one with a START bar and GO/NO-GO lights).**

Remove the four rubber feet (one screw apiece) and slide the base off.

Remove the two hex socket head screws near the rear, along the front-to-back midline of the circuit board (top side; use hexagonal wrench 2.38 mm = .094 in).

Remove the two screws and their washers, below the right and left ends of the test-fixture guide block, taking care not to lose the spring under the START bar, which will become free.

Carefully remove the guide block assembly (not available as a replacement part), which includes the START bar, and which is tethered to the circuit board by a ground wire.

Reassembly note: See above.

c. Clean and check the 4 contact strips. Use a card wet with isopropyl alcohol for cleaning. Hold the board at an angle so that any drip falls away from the circuits.

d. *If necessary for better access for cleaning*, remove 2 front contacts (PIN 1689-1015). Use a hexagonal wrench (2.38 mm, .094 in.) to remove 2 screws per contact. Reassembly note: gap between contacts should not exceed 0.24 mm (.009 in., or the thickness of 3 layers of typing paper); and contacts must press against each other (insulated by tiny dielectric spacers attached near each end of slot) so that a wire of 0.64 mm diameter (AWG 22, .025 in.) can be withdrawn from between them with a force of 1 (minimum) to 2 (maximum) newtons (100 to 200 grams). Tighten the hex-drive screws with a torque of 1.3 to 1.4 newton-meters (12 in-lb).

#### **CAUTION**

Because of alignment difficulty in reassembly, DO NOT use the next step unnecessarily.

e. *If necessary*, remove the 2 remaining contacts as in the previous step. Reassembly note: align the contacts so that the surfaces that will press against the DUT leads are collinear (so that the guide block can be positioned with its slots matching the gaps in BOTH contact pairs); tighten hex-drive screws as specified above.

### **5.6.2 Cleaning the Air Filter**

About once a year (or more often in dusty environments) clean the air filter as follows. The air filter is a spongy piece of plastic found in the air intake vent on the right side of the Digibridge. (See Figure 6-1.) Pull the filter out with your fingers or pliers. Wash it thoroughly in warm water and a mild detergent. Rinse. Squeeze the water out and let it dry completely. Then stuff the air filter into position through the air intake opening; using your fingers, press the edges and corners of the filter into position.

### **5.6.3 Care of the Display Panel**

Use caution when cleaning the display window, not to scratch it nor to get cleaning substances into the instrument. Use soft cloth or absorbent cotton, moistened with a mild glass cleaner, such as "Windex" (Drackett Products Co., Cincinnati, Ohio). DO NOT use a paper towel; do NOT use enough liquid to drip or run.

If it should be necessary to place marks on the window, use paper-based masking tape (NOT any kind of marking pen, which could be abrasive or react chemically with the plastic). To minimize retention of any gummy residue, remove the tape within a few weeks.

## 5.7 TROUBLE ANALYSIS

### 5.7.1 General

#### CAUTION

Only well qualified and trained personnel should attempt trouble analysis. Be sure power is OFF during disassembly and setting up for tests. Carefully observe the HANDLING PRECAUTIONS given at the beginning of Section 5.

*Test Equipment Required.* (Equivalents may be substituted.)

Oscilloscope, Tektronix Model 2201 Digital Oscilloscope. Tektronix, Inc, Beaverton, OR 97077.

Two Probes, Tektronix Model P6103 IOX Probe. Tektronix, Inc, Beaverton, OR 97077.

Multimeter, Fluke Model 45 Dual Display Multimeter. John Fluke Mfg. Co., Inc, Everett, WA 98206.

*Resources.* Refer to Section 4 for a good understanding of the theory of operation. The block diagrams and discussion there provide necessary background, which can generally save time in trouble analysis. Refer to Section 6 for hardware details: circuit layouts, schematic diagrams, and parts lists.

*Abnormal digital signal levels.* Most digital signal levels in this instrument are normally near zero (logic low), about +3.5 to +5 V (logic high), or rapidly switching between these states. Failure of a digital source often produces a dc voltage of about +2 V on a signal line. Use high-impedance probes in measuring. Use a scope as well as a voltmeter, because an average of 2 V may be normal for a digital signal that has a duty cycle near 50%.

*Duplicated circuits and resistor networks.* Some circuits, as in the display board for example, are duplicated several times. The ICs can usually be exchanged between a faulty circuit and a functional one, to identify a "bad" IC. Notice, also, that the resistor networks DB-Z2...DB-Z10 are simply compact packages of 220-ohm resistors. If one resistor is open, it is not necessary to replace the entire package. Use a 5% resistor.

*Power-Up Self Check.* Upon power-up, the Digibridge performs a self-check sequence as explained in paragraph 3.13. If a self-check failure occurs, the instrument display will indicate the nature of the failure. For more detail, refer to paragraph 5.7.2 below.

*Telltale symptoms.* Scan the following group of symptoms for a preliminary analysis of trouble and suggestions for more detailed procedures if applicable.

**Display.** A perpetually blank digit or decimal point may be caused by a fault in the directly associated circuit on the display board. (Refer to comments above.)

**D Error.** A large D error may be caused by faulty "protection" diodes in the analog front end. Check MB-CR30, CR31, CR32, CR33.

Reactance Error. If C or L measurements are not accurate, the test signal source may be at fault. In checking it, verify that frequency is within +/- 0.01% of the specified nominal frequency. Refer to paragraph 3.4.1.

*Keyboard Malfunction.* If instrument passes its power-up self check and proceeds to measure BUT has no (or only a few) keyboard indicators lit, and the keys on the keyboard don't function normally: the fault is probably in the 30-wire cable connection between keyboard and main board. If the keyboard has been disconnected, check for misalignment of the connector that plugs directly into the keyboard. If only one key or indicator malfunctions, check that portion of the keyboard.

*Test Signal.* To check performance of the test-signal source, use a scope to look at the open-circuit signal at the I<sub>h</sub> terminal of the test fixture (right front contact ---be sure there is no DUT). The signal on each range should be an undistorted sine wave at the selected frequency, approximately 850 m V peak to peak.

*Analog Front End and Detector.* To check the entire analog front end, install any typical DUT in the test fixture, select the default test conditions (including CONT MODE) by switching POWER OFF and ON. (The keyboard must not be locked.) Use an oscilloscope to look at the signal at the instrumentation amplifier output (MB-U61 pin 14). This waveform should switch back and forth between two 1-kHz sinewaves whose amplitudes are proportional to the voltages across the DUT and the internal standard resistor. If the DUT is an open circuit or a short circuit, this signal should switch back and forth between a very small and large signal. If these signal levels are incorrect or the signals are distorted, the problem is either in the sinewave generator or in the analog front end. Check this waveform with known "problem" test conditions. If this signal appears to be correct, use an oscilloscope to verify that the signal at MB-U64 pin 7 has the characteristic staircase/sawtooth waveform illustrated in Figure 5-11. If this is true (and if similarly normal waveform appears even when you select known "problem" test conditions), the fault is probably NOT in the analog detector.

*Introduction to Detailed Analysis.* The following trouble analysis procedures will serve as a guide for localizing a fault to a circuit area. In some cases, a specific component part can be isolated for replacement. In other cases, the problem can be narrowed down only to a circuit board.

Except for the short-cuts indicated above, follow the procedure strictly in the order given, doing the principal steps (a, b, c, d,...) until a failure is found. If so, do the secondary steps, if any are given at the point of failure (a1, a2, a3, a4 ...).

#### NOTE

Reference designators, such as MB-U21, are frequently abbreviated in the following text, for example U21, because the context of the service procedure should leave no doubt as to which board is being serviced.

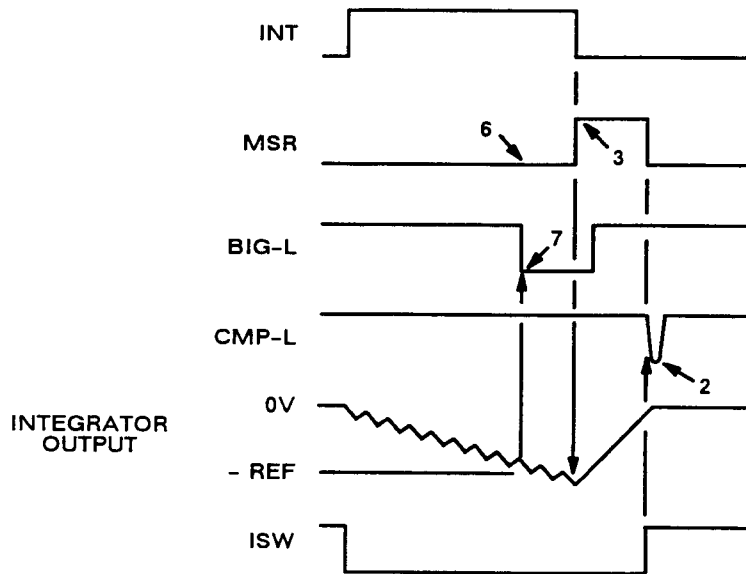

60041.0

Figure 5-11. Timing diagram for the detector portion of the power-up self-check, with keys to the crucial events that are checked. Labels 7 thru 1 correspond to tests identified with displays of 7777 7777 thru 7777 1111, respectively. When the instrument is making measurements, the waveforms are different in many details.

### 5.7.2 Power-Up Self Check and Certain Aborted Measurements

Figure 5-11.

The following outline of failure displays includes comments on some of the self check routines, significance of the displays, and

#### GENERAL NOTES

For the most rigorous self check, in servicing, repeat the power-up self check several times, at least once with a short circuit as "DUT" in the test fixture and once with the test fixture empty (open circuit). A normally functional Digibridge should pass both ways.

Keen observation of the fleeting displays associated with the tests that pass, before the one that fails, are sometimes useful. Pressing any key, such as [SHIFT] will halt the self-test routine and hold the display until the key is released. Look for trends or tests that pass only marginally.

## *SELF-CHECK (FAILURE) DISPLAYS*

88888 8888. RAM read/write exercise failure; Digibridge hangs up. PROCEDURE: Switch POWER OFF and ON to clear hangup and repeat self check. Check RAM circuitry and data and address buses.

77777 XXXX. Detector test failure; Digibridge hangs up. PROCEDURE: Switch POWER OFF and ON to clear hangup and repeat self check. Be sure that the EXTERNAL BIAS switch is OFF. Use scope to check waveforms on the main board as indicated below and in the accompanying figure.

77777 7777. DBIG (U27 pin 2) is stuck low. Integration failure. PROCEDURE: check integrator output (U64 pin 7). Its acquisition, i.e. integration slope (downward) should cross the level of -5.1 V; then BIG-L (U64 pin 14) should go low and DBIG high, signaling the microprocessor to start conversion, i.e. deintegration.

77777 6666. DMSR (U27 pin 8) is stuck high. Integration failure. PROCEDURE: check MSR (U45 pin 11). Both of these signals should be low during integration. Check the circuit back through D flip-flop U45 to PMSR at U27 pin 10.

77777 5555. FCOUNT is not toggling (U27 pins 9, 40). Check the circuit back to frequency multiplexer U19 pin 9. Verify that all frequencies are present on the inputs to the multiplexer and that the control lines FDIV0 and FDIV1 are functioning (U19 pins 2, 14, respectively).

77777 3333. DMSR (U27 pin 8) is stuck low. Integration failure. PROCEDURE: Check MSR (U45 pin 11). Both of these signals should go high, starting the deintegration.

77777 2222. CMP-L (U64 pin 8) is stuck high. Deintegration failure. PROCEDURE: check that integrator output (U64 pin 7) rises to cross the 0-V level at the end of deintegration. CMP-L should go low at that crossing, and may remain low for only a brief pulse. The leading edge should cause DMSR to go low and ISW (U45 pin 6) should go high.

77777 1111. DBIG (U27 pin 2) is stuck high. Deintegration failure. PROCEDURE: verify that BIG-L goes high and DBIG goes low when integrator output becomes more positive than -5.1 V.

66666 XXXX. Stuck key or detector scale factor and zero bias test failure; the Digibridge will loop, automatically repeating the test and updating the display. XXXX is the magnitude of "zero" measurement, normalized to 1.

COMMENT: The "zero" measurement includes a sequence of five dual-slope conversions (measurements of voltage coming into the detector from the instrumentation amplifier). Frequency is 1 kHz; test signal level is 75 mV. The signal component is removed by averaging the results of two dual-slope conversions, sampled in opposite phases. The detector is supposed to be biased so that its "zero" output is essentially in the center of its operating range. For convenience, the CPU divides the "zero" measurement by its normal value and displays the result. Consequently, the ideal value for XXXX is 1.000. If it is less than 0.875 or more than 1.125, the test fails.

ANALYSIS PROCEDURE: Check the following circuits:

1. Zero (half-scale) bias current circuit (CR38, R116).

**NOTE**

R116 is a 10-kilohm potentiometer, which should be adjusted for 2.5 V measured at the cathode of CR38. These components are found about 93 mm (3 5/8 in.) from the right front corner, measured toward center of board.

2. Detector scale (integrator) current circuit (CR40, R119, U63).
3. Phase control circuit (U26, U27, U21, U23, U18, U22).
4. Detector switches (U63).

555 D XXXX. Signal strength check failure; the Digibridge will loop, automatically repeating the test and updating the display. The digit D indicates the range and voltage level used. (See below.) Test frequency is 1 kHz.

COMMENT: Possible cause is having EXTERNAL BIAS switch ON during power-up. The effect depends on what is connected to the EXTERNAL BIAS connector and what is in the test fixture. This switch must be OFF to assure normal power-up routines. Also, check to make sure that the charged capacitor protective fuse has not blown (Item 11, Figure 1-2), the effect is similar. The Digibridge separately squares the measurements of 4 component voltages, a quadrature pair across the DUT and a pair across the internal standard resistor. The squares are summed to represent the square of the applied voltage (essentially the open-circuit voltage from the HIGH terminals of the test fixture to ground). To normalize this result, it is divided by the square of the "zero" measurement. (See 66666 XXXX, above.) The ideal value for XXXX is about 0.64. If it is less than 0.250 or more than 1.000, this test fails.

ANALYSIS PROCEDURE: See below; depends on the failure display, which is coded to indicate test voltage (high or low) and range of the failed test.

555 5 0000. (Confirming symptoms: If you press START repeatedly until the instrument completes its self check, the BIAS ON indicator will be lit even though the EXTERNAL BIAS switch is OFF, no bias is applied, and INT BIAS has not been selected.) The fault is probably in the 6-wire connection between keyboard and main board. Check to be sure that the cable connector properly engages all 6 pins at the keyboard.

555 5 XXXX. Low voltage (75 m V rms), range 4. If XXXX is less than 0.250, check for a malfunction in the circuits that supply the test signal I<sub>h</sub> (U32, U31, U14, U13, U44 ...back to U4). Check the input signals and the gain through instrumentation amplifier U61.

However, if XXXX is greater than 1.000, check the test voltage and source resistance selector circuits (U32, controlled by U27 pins 6, 7); check filter selector U13, controlled by U27 pins 12, 13, as well as pins 14, 15, via U21 and U38. Also check for RAWSINE on D/A converter U44 pin 15.



555 4 XXXX. High voltage (1.275 V), range 4. Check test voltage selector circuit and instrumentation amplifier.

555 3 XXXX. High voltage (1.275 V), range 3. Check signal at I<sub>h</sub> terminal with test fixture short circuited. Check signal at output of transconductance amplifier circuit (U58 pin 8) with test fixture short circuited.

555 2 XXXX. High voltage (1.275 V), range 2. (See previous suggestion.)

555 1 XXXX. High voltage (1.275 V), range 1. (See previous suggestion.)

444 E XXXX. Test frequency and waveform check failure; the Digibridge will loop, automatically repeating the test and updating the display. The digit E indicates the frequency used in the test. (See below.) High voltage test signal is used, on range 4.

COMMENT: Measurement, summing of squares, and normalization are exactly as described for 555 D XXXX. Also, the failure limits for XXXX are the same (0.250 and 1.000), except for tests 1 and 2, which have the limits: 0.125 and 1.000.

ANALYSIS PROCEDURE: Check for the generation of the proper frequency (indicated in code by failure display, see below) by U5, U6, U7, U8, U20, U17, U18, U19, U22. Check filter circuitry in signal source (U13) and detector (U62, U40, U41). Operation can usually be enabled, in spite of failure messages "444 1 XXXX" or "444 2 XXXX", by pressing the START button.

444 6 XXXX. .0118 kHz.  
444 5 XXXX. .0968 kHz.  
444 4 XXXX. 0.480 kHz.  
444 3 XXXX. 1.200 kHz.  
444 2 XXXX. 6.000 kHz.  
444 1 XXXX. 6.0606 kHz.

3333 XXXX. PROM data checksum failure. If the checksum XXXX is not 0000, check all digital circuitry, starting with the 6502 microprocessor U30. Any error on the address or data bus could cause a checksum error --check ROM U35, check RAM U36; check all of the PIAs U3, U25, U26, U27. Look for address or data lines stuck at about 2 V or stuck low.

222 F XXXX. Calibration constants check failure; Digibridge hangs up, but will respond to keyboard inputs. The digit F is the range in question. COMMENT: Each check consists of a comparison between the stored calibration data for the range and the normal, expected values. The calibration can be expressed (essentially) as the conductance of the internal standard resistor. The Digibridge normalizes this conductance by dividing it by the nominal conductance of the standard, and displays the result, XXXX, which should be very close to 1.000. (See table giving source resistance for each range in paragraph 3.4.2.) If XXXX is less than 0.2187 or more than 1.781, this test fails. ANALYSIS PROCEDURE: depends upon display; see below.

NOTE: This is a non-catastrophic failure. If you press the [C/D] key, the Digibridge will proceed with the self-check routine. The instrument can be operated as usual, but results may be erroneous. To restore accuracy, recalibrate, as described in paragraph 5.9.

222 4 XXXX. Range 4 may be incorrectly calibrated. Refer to paragraph 5.9 for recalibration procedure. If calibration is accomplished correctly, but this failure display appears when POWER is cycled OFF and ON, check battery B1. (See Figure 6-4. Connect voltmeter only briefly.) If B1 voltage is less than 2.0 V, replace battery with a new one, as described in paragraph 5.7.3. If the problem is clearly associated with the loss of calibration when POWER is cycled OFF and ON, but the battery voltage is adequate, check the standby power circuit (Q9, Q10, CR9, CR15). Only if necessary, replace the RAM, U36.

222 3 XXXX. Range 3. Be sure that recalibration has been done correctly. If necessary, check Rs standard switching circuitry as described above.

222 2 XXXX. Range 2. Same comment as for range 3.

222 1 XXXX. Range 1. Same comment as for range 3.

222 0 XXXX. Frequency correction factor. ANALYSIS PROCEDURE: Refer to 444 E XXXX.

### 5.7.3 Battery and Fuse Replacement

#### *BATTERY*

If, at power-up, there is a failure display of 222 4 XXXX and investigation shows the most likely cause to be low battery voltage, you probably should replace battery B1. (See power-up self check in paragraph 3.13 and above in 5.7; see part description in Table 1-3 and/or Section 6.) The procedure is as follows.

a. Remove the main board.

b. Find B1 at the right of center (see Figure 6-4). Cut its straps. Observe correct polarity, for replacement, + toward center of board.

#### **WARNING**

Wear safety glasses while doing any work on the battery. DO NOT short or apply voltage to the battery. Dispose of the old one in accordance with local regulations for disposal of hazardous materials. DO NOT incinerate.

c. Unsolder and remove the old battery with care not to overheat.

d. Install the replacement and secure with straps (like the originals) or lacing cord, to safeguard terminals from strain.

e. Solder the terminals with care and DO NOT overheat.

f. Perform complete calibration procedure. Refer to paragraph 5.9.

#### *FUSE*

If at power-up, there is a failure display of 555 5 XXXX (see Self Check paragraph 3.13.1 and Trouble Analysis paragraph 5.7.1) replacement of the capacitor discharge fuse may be necessary (see Table 1-2).

a. Remove the top cover from the Digibridge.

b. This fuse is located in a socket on the main board and behind the power switch. Unplug the fuse (using needle-nose pliers) and replace.

### **5.7.4 Power Supply**

#### NOTE

In the following procedure, do the principal steps (a, b, c, d, ...) as long as everything checks out normally. But if a failure is found, follow the secondary steps, if any are given at the point of failure (a1, a2, a3, a4 ...).

Check the power supply (V a.ssembly) if there is a massive failure (nothing works) or as a starting procedure in any thorough analysis. Refer to Figure 5-3.

#### NOTE

If a voltage regulator (U1, U2, or U3) must be replaced, be sure to spread silicone grease (like Dow Corning compound no. 5) on the surface toward the heat sink. For U1, coat both sides of the insulating washer.

a. Check the output voltages, using a digital voltmeter, with ground reference at V-J1, pin 9 (ribbon cable unplugged), as follows:

Pin 1 = +4.75 V to +5.25 V,

Pin 3 = +4.75 V to +5.25 V,

Pin 4 = -7.6 V to -8.4 V.

a1. If trouble is found at step a, check both analog and digital "+ 5 V" circuit: At outputs of U1 and U2: + 5 V dc (regulated). At WT1 (inputs of U1 and U2): + 10.8 V dc, when primary voltage is 115 V rms, between terminals 1 and 2 of transformer T1. Across input to diode bridge (yellow-to-yellow): 10 V rms.

a2. Check "-8 V" circuit: At output of U3: -8 V dc (regulated). At input (center terminal) of U3: -13.8 V dc, when primary voltage is 115 V rms, between terminals 1 and 2 of transformer T1. Across WT7 to WT8: 11.3 V rms.

a3. Check power-line circuit to primary of transformer V- T1.

b. Make a check similar to step a, with ribbon cable connected, ground reference at front edge of MB board (near the test fixture), probing MB-J5 from below the board, referring to Figure 6-4. (This checks for overload outside the power supply.)

### 5.7.5 Sinewave Generator Checks

Check the MB-board circuits that supply the test signals to the DUT, as follows.

a. Perform the zeroing procedure (both open circuit and short circuit), as described in paragraph 5.9.2 of the recalibration procedure.

b. Make the following test setup and keyboard selections.

```
[FUNCTION] --- MEASURE  
[DISPLAY] --- VALUE  
[MEASURE RATE] -- SLOW  
[MODE] --- CONT.  
[EQUIVALENT CIRCUIT] --- SERIES
```

c. Install a 10 kilohm resistor as the DUT.

d. Use an oscilloscope to verify that the signal at the right-hand end of the DUT in the test fixture is a sine wave, as follows. (For scope ground return, connect to the ground plane on the circuit board or via a 6-32 screw to the tapped hole in the left-hand end of the test fixture.)

```
Frequency ---1 kHz,  
Amplitude ---approx 560mV pk-pk
```

e. If no fault appears in steps a through d, skip to paragraph 5.7.6.

#### NOTE

The prefix "MB-" is omitted in the following text, wherever it is not necessary for clarity.

f. With an oscilloscope, observe and measure the signal at U32 pin 15. It must be a 1-kHz sinewave, approximately 880 mVpk-pk.

g. With an oscilloscope, check at U31 pin 8, U14 pin 14, and U14 pin 8, for a 1-kHz sinewave, 880 mVpk-pk.

If the test signal is missing, check backward, to the precision oscillator U4, then forward through dividers and sinewave generator, as shown on the main-board schematic sheet 2, in Section 6 of this manual.

### 5.7.6 Front End Amplifiers and Switches

Check the MB-board analog circuits that process the measurement signals from the test fixture to the point of A/D conversion, as follows.

a. Verify that there is a normal test signal at the test fixture. (See paragraph 5.7.5 step d, above.)

b. Check the range switching circuitry as follows. (Be sure that the RANGE HELD indicator is NOT lit.)

Insert as DUT each of following resistors. With a scope connected to the right side of each DUT in turn, check for a 1-kHz sinewave with the level indicated below.

- 10 ohm ---test signal should be 250 mVpk-pk (range 4)
- 1 kohm ---test signal should be 650 mVpk-pk (range 3)
- 10 kohm ---test signal should be 560 mVpk-pk (range 2)
- 1 Mohm ---test signal should be 800 mVpk-pk (range 1)

If discrepancy is found in step b, check for 880 m Vpk-pk at the appropriate signal source check point -as described in Table 5-3 --for the particular range in use.

c. Install a 1-kilohm resistor in the test fixture. Check the PH circuit at U59 pin 8, for a 1-kHz sinewave, 650 m Vpk-pk.

If there is discrepancy in step c, but U59 pin 10 has a 650 m Vpk-pk sinewave, then U59 is faulty.

d. Check the output of the IL circuit at U59 pin 14 for a 1-kHz sinewave, with the following selection of DUTs in turn:

- 10 ohm ---signal level should be 550 mVpk-pk (range 4)
- 1 kohm ---signal level should be 250 m Vpk-pk (range 3)
- 10 kohm ---signal level should be 350 m Vpk-pk (range 2)
- 1 Mohm ---signal level should be 100 mVpk-pk (range 1)

If a discrepancy is found in step d, check similarly at the R-Std signal check point --as described in Table 54. The signal should be the same as listed in step d above for U59 pin 14, for the particular DUT and range.

**Table 5-3  
SOURCE RESISTOR RANGE SWITCHING CHECKS**

RNG1	Control Signals		Range	Nom Source Resistance	Signal Source Check Point
	RNG0	LSRC			
0	0	0	4	25 ohm	U32 pin 12
0	1	1	3	400 ohm	U32 pin 14
1	0	1	2	6.4 kohm	U32 pin 15
1	1	1	1	97.4 kohm	U32 pin 11

**Table 5-4  
DETECTOR (STANDARD) RESISTOR RANGE SWITCHING CHECKS**

Control Signals			Range	Nominal Standard Resistance	R-Std Signal Check Point
RNG1	RNG0	LSTD			
0	0	0	4	25 ohm	U56 pin 12
0	1	1	3	400 ohm	U56 pin 14
1	0	1	2	5.97 kohm	U56 pin 15
1	1	1	1	97.4 kohm	U56 pin 11

## 5.8 ACCURACY VERIFICATION

### 5.8.1 General

This procedure is a more rigorous alternative to the performance verification described above. Precision standards of impedance are required for this procedure, which checks the accuracy as well as the overall performance of the instrument. It will be controlled from the front panel, without disassembly. Table 5-5 lists the recommended standards and associated equipment. For the C accuracy checks, the standard is a precision decade capacitor.

Calibration of Standard. The acceptable RLC readout (min to max range) may have to be modified if the actual (calibrated) value of your standard or its accuracy (either or both) is different from the tabulated value(s).

For example, if your 10-pF standard is known to be 10.18 +/- 0.25 pF, then compute the new tolerance as follows: Digibridge accuracy + / -0.02 percent. The limits are, therefore, 9.92 to 10.44 pF.

Verify that the instrument meets performance specifications as follows.

**Table 5-5  
EQUIPMENT FOR ACCURACY VERIFICATION**

Name	Requirements	Recommended
Capacitor	Decade, 3-terminal, 1 pF to 1 uF, accuracy: $\pm 0.05\%$ $\pm 0.5$ pF	GenRad 1413-9700
Capacitor	Decade, 50 pF to 1.11115 uF, accuracy: $\pm 0.5\%$	GenRad 1412
Extender cable	Adapt test fixture to type 874 connectors	GenRad 1688-9600
Adaptors (2 req'd)	Tee with type 874 connectors	Gilbert 0874-9910*
Extender cable	Adapt test fixture to binding posts and banana plugs	GenRad 1657-9600
Capacitor	Four-terminal, ratio type, 10 uF to 100 uF, accuracy: $\pm 0.25\%$	GenRad 1417-9700
Capacitor	DC blocking, 500 uF, 10 V	GE 69F2214G2
Capacitor	Three-terminal, 1 uF, acc: $\pm 0.02\%$ , certified within $\pm 0.03\%$ including effects of aging since last certification	GenRad 1409-Y
Resistor	Decade, 3-terminal, 1 ohm to 1 Mohm, accuracy: $\pm 0.01\%$	GenRad 1433-H
Inductors	Fixed, 2-terminal, 1 mH, $\pm 0.1\%$	GenRad 1482-E
	100 mH, $\pm 0.1\%$	GenRad 1482-L
	1 H, $\pm 0.1\%$	GenRad 1482-P
	10 H, $\pm 0.1\%$	GenRad 1482-T

\*Gilbert Engineering Co., Inc., 5310 W. Camelback Rd, Glendale, AZ 85301

### 5.8.2 Capacitance Measurement Accuracy (Small and Medium C, Ranges 1, 2, 3)

Make the test setup and verify instrument performance as follows:

#### CAUTION

Be sure the line voltage switch, rear panel, is correctly set for your power line voltage.

a. After the line voltage switch has been set to correspond to the input line voltage, connect the power cord and switch POWER ON.

b. Connect the 1688-9600 extender cable (type 874 connectors) to the Digibridge test fixture, as described in paragraph 3.2.5. The screws must be hand tightened because they provide the ground (guard) connection.

c. Connect the "high" leads (red and red white) to one of the 874 Tee connectors. Connect the "low" leads (black and black/white) to the other 874 tee.

d. Before measurement, zero the Digibridge as follows. In this process, the Digibridge automatically measures stray parameters and retains the data, which it uses to correct measurements so that results represent parameters of the DUT alone, without (for example) test- fixture or adaptor capacitance.

Be sure that MEASURE RATE is SLOW and that the RANGE HELD indicator is NOT lit. DO NOT have test frequency programmed to other than 1 kHz.

#### *Open Circuit.*

Leave the two type 874 tees connected to the 1688-9600 extender cable, but not connected to each other.

Press [FUNCTION] key (if necessary) to select MEASURE function.

Press [MODE] key (if necessary) to select TRIGGERED mode.

Press these keys deliberately: [1] [6] [5] [9] [=] [SHIFT] [OPEN].

Confirm that the GO indicator is lit. Press the START button.

Keep hands and objects at least 10 cm (4 in.) from test fixture.

Wait for the GO indicator to be lit again, on the keyboard (not on any remote test fixture). (The RLC display should be .00000)

#### *Short Circuit.*

Connect the two type 874 tees together.

Press these keys deliberately: [1] [6] [5] [9] [=] [SHIFT] [SHORT].

Confirm that the GO indicator is lit. Press the START button.

Wait for the GO indicator to be lit again, on the keyboard (not on any remote test fixture).

Disconnect the two type 874 tees from each other.

e. Connect the type 874 tee with the red cables to the HIGH terminal of the 1413-9700 decade capacitor. Connect the other tee (black cables) to the LOW terminal of this capacitor.

f. Set the decade capacitor dials to 00000 pF.

Press the C /D key.

Press these keys deliberately: [1] [6] [5] [9] [=] [SHIFT] [OPEN].

Confirm that the GO indicator is lit. Press the START button.

Wait for the GO light. The RLC display should be .00000 pF.

Press [MODE] key to select CONT.

Press [EQUIVALENT CIRCUIT] key to select SERIES.

g. Set the decade capacitor to 10 pF. If necessary, press the START button. Verify that the C and D measurements subsequently displayed on the Digibridge are within the limits given in the first line of Table 5-6.

h. Similarly, for each line in the table, set the capacitor and the Digibridge measurement rate, and verify that the resulting measurements are satisfactory.

i. Disconnect the 1688-9600 extender cable from the capacitor and the Digibridge.



NOTE

Whenever doing short-circuit or open-circuit zeroing, remember that the GO light to watch is the one on the keyboard (not on any remote test fixture, for example).

**Table 5-6  
CAPACITANCE ACCURACY CHECKS (RANGES 1 TO 3)**

Capacitor Setting	Meas Rate	Digibridge Accuracy	Decade C Accuracy	RLC Display Min*	RLC Display Max*	QD Display Max**
----- Range 1 -----						
10 pF	SLOW	1.10%	5.05%	9.385	10.615	6100 ppm
100 pF	SLOW	.20%	.55%	99.25	100.75	2500 ppm
1500 pF	SLOW	.11%	.083%	1497.1	1502.9	700 ppm
1500 pF	MED	.21%	.083%	1495.6	1504.4	1002 ppm
1500 pF	FAST	.53%	.083%	1490.8	1509.2	1705 ppm
6400 pF	SLOW	.10%	.058%	6389.9	6410.1	500 ppm
----- Range 2 -----						
10 nF	SLOW	.10%	.055%	9.9845	10.016	200 ppm
25 nF	SLOW	.10%	.052%	24.962	25.038	200 ppm
25 nF	MED	.20%	.052%	24.937	25.063	500 ppm
25 nF	FAST	.50%	.052%	24.862	25.138	1200 ppm
100 nF	SLOW	.10%	.051%	99.849	100.15	200 ppm
----- Range 3 -----						
200 nF	SLOW	.10%	.05%	199.70	200.30	200 ppm
400 nF	SLOW	.10%	.05%	399.40	400.60	200 ppm
400 nF	MED	.20%	.05%	399.00	401.00	500 ppm
400 nF	FAST	.50%	.05%	397.80	402.20	1200 ppm
1000 nF	SLOW	.10%	.05%	998.50	1001.5	200 ppm

\*These ranges of acceptable displays are based on specified accuracy of decade capacitor, recently calibrated. If the capacitor values are known to higher accuracy by special calibration or lesser accuracy because of long-term drift, the acceptable RLC max and min criteria must be revised accordingly.

\*\*Based on D values stated in GenRad documentation for the type 1413 decade capacitor. If capacitor D values are known more accurately, the acceptable QD display criteria can be reduced accordingly.

**Table 5-7  
CAPACITANCE ACCURACY CHECKS (RANGE 4)**

Capacitor Setting	Digibridge Accuracy	C-Standard Accuracy	RLC Display (Uncorrected)		RLC Display Correction (See text)	Acceptable D	
			Min	Max		Min	Max
1 uF	-----	-----	(Used to determine K)			.0085	.0115
10 uF	.10%	.07%	9.983	10.017	+10K	.0085	.0115
100 uF	.15%	.07%	99.78	100.22	+100K	.0085	.0115

**5.8.3. Capacitance Measurement Accuracy (Large C, Range 4)**

This procedure follows after paragraph 5.8.2. (Leave the test frequency at 1 kHz, the measure rate SLOW, the selected parameter C/D, and the RANGE HELD indicator NOT lit.)

- a. Connect the 1657-9600 extender cable (with banana plugs) to the Digibridge test fixture. Hand-tighten the screws, to provide the ground (guard) connection.
- b. Connect the "high" leads (red and red/white) together. Separately connect the "low" leads (black and black-white) together.
- c. Before measurement, zero the Digibridge as follows:

*Open Circuit.*

Leave the high (red) banana plug stack disconnected from the low (black) stack  
 Press [FUNCTION] key (if necessary) to select MEASURE.  
 Press [MODE] key (if necessary) to select TRIGGERED mode.  
 Press these keys deliberately: [1] [6] [5] [9] [=] [SHIFT] [OPEN].  
 Confirm that the GO indicator is lit.  
 Keep hands and objects at least 10 cm (4 in.) from test fixture.  
 Press the START button.  
 Wait for the GO indicator to be lit. The RLC display should be .00000 pF.

*Short Circuit.*

Connect the two banana plug stacks together; leave the guard (black/green) open.  
 Press these keys deliberately: [1] [6] [5] [9] [=] [SHIFT] [SHORT].  
 Confirm that the GO indicator is lit.  
 Press the START button.  
 Wait for the GO indicator to be lit. The RLC display should be .00000 ohms.  
 Press the [MODE] key to select CONT.

- d. Connect the three-terminal 1-uF capacitance standard (GR 1409- Y) as follows. This standard should be certified to an accuracy of +/-0.03% including the effects of aging.

RED,	IH	---	capacitor H binding post
RED & WHITE,	PH	---	stacked on the red banana plug
BLACK,	IL	---	capacitor L binding post
BLACK & WHITE,	PL	---	stacked on the black banana plug
BLACK & GREEN,	G	---	capacitor G, NOT linked to L

e. Verify that the RLC display agrees with the certified value of the standard (corrected for temperature if appropriate) within +/-0.0013 uF which is the sum of .03% for the standard and 0.1% for the Digibridge.

f. Calculate the difference D1, as follows, and retain it for future use

$$D1 = (\text{displayed measurement}) - (\text{value of standard}) \text{ uF}$$

g. Remove the 1-uF standard and connect the 4-terminal ratio-type capacitance standard (GR 1417) and the blocking capacitor (500 uF) as follows. Be sure that the dc blocking capacitor is fully discharged before connecting it. Notice that only the left-hand terminals of the standard are used.

RED,	IH	---	+ end of blocking capacitor
- end of blocking cap	cap	---	CURRENT H terminal of capacitance standard
RED & WHITE,	PH	---	POTENTIAL H terminal of capacitance standard
BLACK,	IL	---	CURRENT L terminal of capacitance standard
BLACK & WHITE,	PL	---	POTENTIAL L terminal of capacitance standard
BLACK & GREEN,	G	---	uninsulated terminal of capacitance standard

h. Set the dials on the capacitance standard thus:

CAPACITANCE --1 uF  
 TEST FREQUENCY ---1 kHz

NOTE

For detailed information on the GR 1417 4-Terminal Capacitance Standard, refer to its instruction manual.

i. Read the RLC display, which should be close to the nominal value of the standard: 1 uF.

j. Calculate the difference D2, as follows, and retain it for future use

$$D2 = (1.0000 \text{ uF}) - (\text{displayed measurement}) \text{ uF}$$

NOTE: The DQ display should show D = .0085 to .0115.

k. Calculate the calibration factor K as follows.

$$K = D1 + D2 \quad (\text{uF})$$

*Example.* Suppose that in step e, the display is 1.0013, and the value of the standard is 1.0006; then D1 = +.0007 uF. In step i, the nominal is 1.0000; suppose that the display is 1.0024; then D2 = -.0024uF. The correction K would therefore be:

$$K = +.0007 - .0024 = -.0017 \text{ (uF)}.$$

l. Reset the capacitance-standard dial to: CAPACITANCE = 10 uF.

m. Read the RLC display and correct it by adding 10K. (For. example, if the display is 10.023 uF and if K = -.0017, the corrected measurement is 10.006 uF.) Verify that the corrected measurement is within the acceptable extremes for the 10 uF setting in Table 5-7.

n. Reset the capacitance-standard dial to: CAPACITANCE = 100 uF. Read the RLC display and correct it by adding 100K. As in step m, verify that the corrected measurement is within the acceptable extremes shown in Table 5-7.

**Table 5-8**  
**RESISTANCE ACCURACY CHECKS (at 1 kHz)**

Standard Resistor Setting	Equivalent Circuit	Measure Rate	Typical Standard Accuracy*	Digibridge Accuracy	RLC Display Acceptable Extremes*
10.00 orums	Series	SLOW	.0~	.11%	9.986 to 10.014
25.00 orums	Series	SLOW	.018%	.10%	24.971 to 25.029
25.00 orums	Series	NED	.018%	.21%	24.943 to 25.057
25.00 orums	Series	FAST	.018%	.52%	24.866 to 25.134
90.00 orums	Series	SLOW	.012%	.10%	89.899 to 90.101
200.0 orums	Series	SLOW	.011%	.10%	199.78 to 200.22
400.0 orums	Series	SLOW	.01%	.10%	399.56 to 400.44
400.0 orums	Series	NED	.01%	.20%	399.16 to 400.84
400.0 orums	Series	FAST	.01%	.50%	397.96 to 402.04
1500 orums	Parallel	SLOW	.01%	.10%	1498.4 to 1501.6
2000 orums	Parallel	SLOW	.01%	.10%	1997.8 to 2002.2
6400 orums	Parallel	SLOW	.01%	.10%	6393.0 to 6407.0
6400 orums	Parallel	NED	.01%	.20%	6386.6 to 6413.4
6400 orums	Parallel	FAST	.01%	.50%	6367.4 to 6432.6
24 kilorums	Parallel	SLOW	.01%	.10%	23.974 to 24.026
30 kilorums	Parallel	SLOW	.01%	.10%	29.967 to 30.033
100 kilorums	Parallel	SLOW	.01%	.10%	99.89 to 100.11
100 kilorums	Parallel	NED	.01%	.21%	99.78 to 100.22
100 kilorums	Parallel	FAST	.01%	.52%	99.47 to 100.53

\* If the calibrated value of the resistance standard is slightly different from the nominal value, or if the standard's accuracy is different from the typical accuracy, correct the "acceptable extremes" accordingly.

#### 5.8.4 Resistance Measurement Accuracy

This procedure follows after paragraph 5.8.3. (Thus, test frequency = 1 kHz, measure rate = SLOW, range held indicator is NOT lit, and parameter C/D is specified.)

a. With the Digibridge still connected to the 1657-9600 extender cable, connect its banana plugs to the 1433-H Decade Resistor as follows:

- "high" leads (red and red/white) to the H binding post
- "low" leads (black and black/white) to the L binding post
- guard lead (black/green) to the G binding post.
- Disconnect any link between the G and L binding posts.

b. Set the decade resistor dials to 00000 ohms.

- Press the [R/Q] key.
- Press [MODE] key to select TRIGGERED.
- Press these keys deliberately: [1] [6] [5] [9] [=] [SHIFT] [SHORT].
- Confirm that the GO indicator is lit. Press the START button.
- Wait for the GO indicator to be lit again. The RLC display should be .00000 ohms.
- Press [MODE] key to select CONT.

c. Refer to Table 5-8. Set the decade resistor dials to 0000010, as indicated in the first line of the table and verify that the RLC display is between the extremes listed. Repeat for each line of the table, setting the decade resistor dials, Digibridge equivalent circuit, and measurement rate, and verifying the results, as tabulated.

### 5.8.5 Inductance Measurement Accuracy

This procedure follows after paragraph 5.8.4. (Thus, test frequency = 1 kHz, measure rate = SLOW, range held indicator is NOT lit, and parameter R/Q is specified.)

a. Connect the 1657-9600 extender cable to the Digibridge test fixture. Hand tighten the screws, to provide ground (guard) connection.

b. Connect the "high" leads (red and red/white) together and separately connect the "low" leads (black and black/white) together.

c. Before measurement, zero the Digibridge as follows:

#### *Open Circuit.*

- Keep the "high" banana-plug stack separated from the "low" stack.
- Press [FUNCTION] key (if necessary) to select MEASURE function.
- Press [MODE] key (if necessary) to select TRIGGERED mode.
- Press these keys deliberately: [1][6][5][9][=][SHIFT][OPEN].
- Confirm that the GO indicator is lit.
- Keep hands and objects at least 10 cm (4 in.) from test fixture.
- Press the START button.
- Wait for the GO indicator to be lit again. The RLC display should be .00000 pF.

#### *Short Circuit.*

- Connect the 2 banana plug stacks together, leave the guard (black/green) open.
- Press these keys deliberately: [1][6][5][9][=][SHIFT][SHORT].
- Confirm that the GO indicator is lit.
- Press the START button.
- Wait for the GO indicator to be lit again. The RLC display should be .00000 ohms.
- Press the [MODE] key to select CONT.

**Table 5-9**  
**INDUCTANCE ACCURACY CHECKS (at 1 kHz)**

Standard Inductor	Range	Typical RLC Display*			Acceptable Extremes	Expected Q**
		Measure Rate	Digibridge Accuracy	Standard Accuracy		
1 mH	4	SLOW	.11%	0.1%	.9979 to 1.0021	7.5
		MED	.22%	0.1%	.9968 to 1.0032	---
		FAST	.55%	0.1%	.9935 to 1.0065	---
100 mH	3	SLOW	.10%	0.1%	98.80 to 100.20	7.5
		MED	.20%	0.1%	99.70 to 100.30	---
		FAST	.50%	0.1%	99.40 to 100.60	---
1 H	2	SLOW	.10%	0.1%	.9980 to 1.0020	10
		MED	.20%	0.1%	.9970 to 1.0030	---
		FAST	.50%	0.1%	.9940 to 1.0060	---
10 H	1	SLOW	.10%	0.1%	9.980 to 10.020	10
		MED	.21%	0.1%	9.969 to 10.031	---
		FAST	.52%	0.1%	9.938 to 10.062	---

\* These ranges of acceptable displays are based on specific accuracy of decade inductors, recently calibrated. If the inductance values are known to higher accuracy by special calibration or lesser because of long-term drift, the "acceptable RLC extremes" must be revised accordingly.

\*\* Based on Q of Type 1482 Standard Inductor, as stated in GenRad documentation. If inductor Q values are known more accurately, the Q can be checked to tighter tolerances.

d. Connect the banana plugs of the 1687-9600 extender cable (and the ground link) to the 1-mH inductance standard (1482-E) as tabulated below.

LOW binding post of inductor to its case (ground), using the link  
 "high" leads (red and red/white) to the LOW binding post (and case)  
 "low" leads (black and black/white) to the HIGH binding post  
 Guard lead (black/green) hanging free

e. Press the [L/Q] key to select inductance parameter. Press the [EQUIVALENT CIRCUIT] key (if necessary) to select SERIES.

f. Refer to Table 5-9 and verify that the RLC display is between the extremes listed for 1 mH, SLOW measurement rate (first line of table).

g. Similarly, Standard Inductor with the other inductance standards (1 mH, 100 mH, 1 H, and 10 H), as indicated in the column, and with the indicated measurement rate, verify that the RLC display is acceptable for each line of the table, for ranges 4, 3, 2, and 1.

### 5.8.6 D Measurement Accuracy

Verify D-measurement accuracy with the following procedure. Dissipation-factor checks will be made using series equivalent circuit, with corresponding connections of resistance and capacitance standards.

This procedure follows after paragraph 5.8.5. (Thus, test frequency = 1 kHz, measure rate = SLOW, range held indicator is NOT lit, and parameter L/Q is specified.)

a. Connect the 1657-9600 extender cable to the Digibridge test fixture. Hand tighten the screws, to provide ground (guard) connection.

b. Connect the "high" leads (red and red/white) together and separately connect the "low" leads (black and black/white) together.

c. Press [SHIFT] [FREQUENCY] repeatedly to select 100 Hz.

d. Before measurement, zero the Digibridge as follows:

#### *Open Circuit.*

Keep the "high" banana-plug stack separated from the "low" stack.  
Press [FUNCTION] key (if necessary) to select MEASURE function.  
Press [MODE] key (if necessary) to select TRIGGERED mode.  
Press these keys deliberately: [1] [6] [5] [9] [=] [SHIFT] [OPEN].  
Confirm that the GO indicator is lit.  
Keep hands and objects at least 10 cm (4 in.) from test fixture.  
Press the START button.  
Wait for the GO indicator to be lit again. The RLC display should be .00000 pF.

#### *Short Circuit.*

Connect the 2 banana plug stacks together, leave the guard (black/green) open.  
Press these keys deliberately: [1] [6] [5] [9] [=] [SHIFT] [SHORT].  
Confirm that the GO indicator is lit.  
Press the START button.  
Wait for the GO indicator to be lit again. The RLC display should be .00000 ohms.  
Press the [MODE] key to select CONT.

e. Using the extender cable and plain bus wire, connect the decade Rand C standards in series, as DUT to the Digibridge, as shown in Figure 5-12 and tabulated below.

RED, I+ --stack on P+  
RED & WHITE, P+ --resistor H  
BLACK, I- --stack on P  
BLACK & WHITE, P- --capacitor L  
BLACK & GREEN, G --resistor G and capacitor G (connected with a link or bus wire).  
*Also connect with a short jumper:* from resistor L to capacitor H.

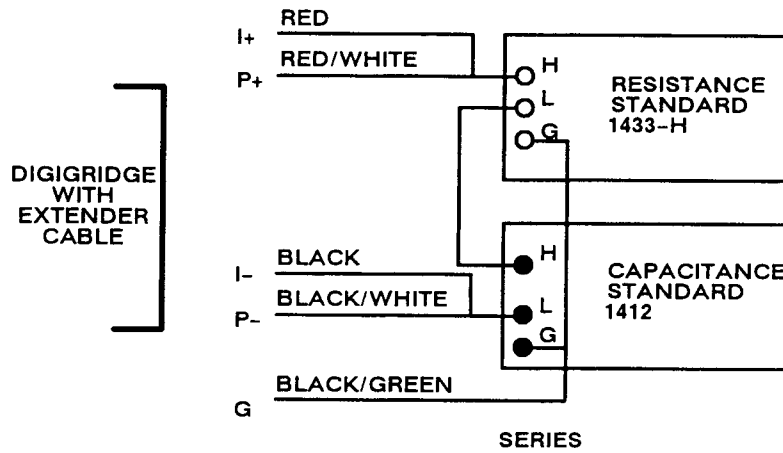

60042.0

Figure 5-12. Series connections of standards for D accuracy checks

f. Confirm or select measurement conditions on the Digibridge thus:

DISPLAY	---	VALUE
MEASURE RATE	---	SLOW
EQUIVALENT CIRCUIT	---	SERIES
FREQUENCY	---	100 Hz
MODE	---	CONT
HOLD RANGE	---	autorange
Parameter	---	C/D
EXT BIAS	---	OFF

g. Set the resistance and capacitance standards to the values given in line 1 of Table 5-10. Verify that the DQ display is within the range given, inclusive. Lock in this range on the 1659 by pressing [HOLD RNG].



**Table 5-10  
D-ACCURACY CHECK**

Resistance Standard	Capacitance Standard (100 Hz)	DQ Display (Min to Max)
50 ohms	0.1592 uF*	.0045 to .0055
100 ohms	same*	.0095 to .0105
500 ohms	same*	.0495 to .0505
1 kilohm	same*	.0995 to .1005
5 kilohms	same*	.4994 to .5006
10 kilohms	same*	.9990 to 1.001
50 kilohms	same*	4.987 to 5.013
90 kilohms	same*	8.959 to 9.041

\* Set the capacitance standard to obtain, on the RLC readout, the tabulated capacitance.

h. Continue down the table, verifying each line. Because the capacitance in the series equivalent circuit is different from the decade capacitor setting when the series resistance is large, use the RLC readout to indicate capacitance in those lines of the table.

### 5.8.7 Limit Comparison Bins

Verify the Digibridge performance with regard to limit comparison and bin assignments as follows. The resistance standard 1433-H (Figure 5-12) or equivalent is required for this test.

a. Confirm or select measurement conditions on the Digibridge as listed:

```

FUNCTION          --- ENTER
DISPLAY           --- VALUE
MEASURE RATE      --- SLOW
EQUIVALENT CIRCUIT --- SERIES
FREQUENCY         --- 1 kHz (repeatedly press [SHIFT][FREQUENCY] if necessary)
MODE              --- CONT
EXT BIAS          --- OFF
Range             --- Select range 3 by repeatedly pressing [R/Q] for the first
                    kΩ range and then press [HOLD RNG] if necessary to hold the range.
  
```

b. Connect the 1657-9600 extender cable from the Digibridge as follows:

- "high" leads (red and red/white) --to-- resistor H.
- "low" leads (black and black/white) --to-- resistor L.
- "ground" lead (black/green) --to-- resistor G.

c. Refer to Table 5-11. After making the sequence of keystrokes (using the appropriate limit entry keys) shown under "Entry", verify that the Digibridge numerical displays are like the numbers tabulated in the same row of the table under "Displays". Make all entries as tabulated.

**Table 5-11  
ENTRY OF LIMITS**

Entry		RLC Display	DQ Display
(none)		(blank)	(blank)
[5]	[=] [SHIFT] [NOM VALUE]	5.0000	(blank)
[.]	[1] [=] [SHIFT] [BIN No.] [0]	(blank)	.1000
[1]	[%] [=] [SHIFT] [BIN No.] [1]	5.0500	4.950
[2]	[%] [=] [SHIFT] [BIN No.] [2]	5.1000	4.900
[3]	[%] [=] [SHIFT] [BIN No.] [3]	5.1500	4.850
[4]	[%] [=] [SHIFT] [BIN No.] [4]	5.2000	4.800
[5]	[%] [=] [SHIFT] [BIN No.] [5]	5.2500	4.750
[6]	[%] [=] [SHIFT] [BIN No.] [6]	5.3000	4.700
[7]	[%] [=] [SHIFT] [BIN No.] [7]	5.3500	4.650
[8]	[%] [=] [SHIFT] [BIN No.] [8]	5.4000	4.600

d. Select on the Digibridge:

FUIX:Jr l aJ" ---MFAS URE  
DISPLA.Y ---BIN No.

e. Refer to Table 5-12. For each setting of the resistance standard, verify that the DQ display is blank, the bin (RLC) display is a single digit as tabulated, and the GO/NO-GO lights work as tabulated.

**Table 5-12  
BIN ASSIGNMENT CHECK**

R Standard Set To	GO/ NO-GO	Bin Display
5000 ohms	GO	1
5057 ohms	GO	2
5107 ohms	GO	3
5157 ohms	GO	4
5207 ohms	GO	5
5257 ohms	GO	6
5307 ohms	GO	7
5357 ohms	GO	8
5407 ohms	NO-GO	9
0000 ohms	NO-GO	0
5000 ohms	GO	1

NOTE

When the handler interface option is present the bin signal lines can be checked with a scope (during the above procedure) to verify their logic "low" state. Refer to the interface option schematic in Section 6.

**5.9 RECALIBRATION**

**5.9.1 Preparation**

*Introduction.* This service procedure requires a set of external calibration resistors whose R and Q values are exactly known (see table in next paragraph). After recalibration, the Digibridge retains in RAM the corrections that the microprocessor needs to compensate for the small errors in the actual values of the internal standard resistor parameters. (Therefore, the Digibridge calculates its measurement results correctly, accomplishing by calculation the same result that would be obtained if the recalibration process actually trimmed the internal standards exactly to their nominal values.)

*Required Equipment.* Refer to Table 5-13.

**Table 5-13  
EQUIPMENT FOR RECALIBRATION**

GenRad No.	Description	Requirements
-----	Temperature stabilized room	23 degrees C (73.4 F) recommended
1689-9604	Kit of four calibration resistors with nominal resistances of 24.9, 374 ohms; 5.97, 95.3 kilohms, and calibration "open" and "short".	R and Q values known at 1 kHz, R accuracy +/- .002%, calibration traceable to NBS; Q calibrated to +/- 25 ppm. *

\* Refer to calibration certificate (Form No. 1689-8204) supplied with the kit.

*Procedure.*

- a. Remove any adaptor that may be in the test fixture. Inspect the Digibridge test fixture for cleanliness. If it is dirty or if it is scheduled for periodic cleaning soon, clean the test fixture as described in paragraph 5.6.
- b. Place all equipment including the Digibridge(s) to be recalibrated in the temperature stabilized room, normally at 23 degrees C.
- c. Switch Digibridge(s) ON and allow it to stabilize at room temperature for at least two hours. Leave the Digibridge test conditions at the defaults.

## 5.9.2 Zeroing

This zeroing procedure is like the routine procedure in Operation, Section 3. In this process, the Digibridge automatically measures stray parameters related to the test fixture and associated circuits and retains the data, which it uses in each recalibration step below to correct measurements so that results most accurately represent parameters of the external calibration resistor alone.

### *Open Circuit.*

Press [FUNCTION] key (if necessary) to select :MEASURE function.  
Press [MODE] key (if necessary) to select TRIGGERED mode.  
Be sure that the test fixture is open circuited.  
Press these keys: [1] [6] [5] [9] [=] [SHIFT] [OPEN]. (A zero in each, left and right displays, and the GO indicator should be lit, confirming this step.)  
Keep hands and objects at least 10 cm (4 in.) from test fixture.  
Press the START button. The GO indication disappears.  
Wait for the GO indicator to be lit again (approximately 10 seconds).

### *Short Circuit.*

Short the fixture with a very low-resistance "short circuit".  
Press the keys: [1] [6] [5] [9] [=] [SHIFT] [SHORT]. (A 5 in each, left and right displays, and the GO indicator should be lit, confirming this step.) Keep away from test fixture.  
Press the START button. The GO indication disappears.  
Wait for the GO indicator to be lit again (approximately 10 seconds).  
The RLC display should be .00000 (ohms or mH).  
Disconnect the short circuit.

## 5.9.3 Recalibration for Range 4

a. Connect the 24.9-ohm calibration resistor to the Digibridge test fixture.

b. Select ENTER with [FUNCTION] key and CONTINUOUS with [MODE] key. To select range 4 first, sequence through all four ranges by depressing the R/Q key several times. Notice that the units LEDs will show 0 on two ranges (4 and 3) and kO on the other two ranges (2 and 1). Stop on the first 0 range (i.e., as the units LED changes from kW to 0); this is range 4.

c. Enter the known parameters of the calibration resistor as in the following example, based on the values  $R = 24.895$  ohms and  $Q = 15$  ppm. (NOTES: The Digibridge will accept six digits for R, even though only five will be displayed. The Q is associated with "bin 0", and should be entered as an absolute value, 6 digits maximum and preceded with "-" if the known Q is negative. Although, only 4 digits are shown, all 6 are used in the calibration.

Press [2][4][.] [8] [9] [5] [=] [SHIFT] [NOM VALUE]

NOTE: the calibration resistance value should appear in the left display.

Press [.] [0] [0] [0] [0] [1] [5] [=] [SHIFT] [BIN NO] [0]

NOTE: The calibration Q value (first 4 digits only, to the right of the decimal point) should appear in the right-hand display.

d. Enable and execute the recalibration for this range as follows. (The following keystrokes are the same for any range.)

Select MEASURE with the [FUNCTION] key and TRIGGERED with [MODE] key.

Press [1][6][5][9][=][1][SHIFT][CALIBRATE]

NOTE: The GO indicator being lit and a 6 in the left and a 6 in the right displays confirm: *calibration is enabled.*

Press START (The GO indicator remains unlit while calibration proceeds.) Keeping hands away from the test fixture, wait until the GO indicator is lit again. This completes recalibration of one range.

e. Check as follows that the Digibridge operates properly with the recalibration.

Select CONTINUOUS with the [MODE] key. The Digibridge should measure the calibration resistor like any ordinary resistor and display its R and Q values. The Q display should indicate zero.

f. Disconnect the calibration resistor from the test fixture.

#### 5.9.4 Recalibration for Range 3

a. Connect the 374-ohm calibration resistor to the Digibridge test fixture.

b. Select ENTER with [FUNCTION] key and verify that measure MODE is CONT. Press the R/Q key and sequence to the second  $\Omega$  range (as discussed in paragraph 5.9.3) this is range 3.

c. Enter the known parameters of the calibration resistor as in the following example, based on the values  $R = 374.06$  ohms and  $Q = 5$  ppm. (NOTES: The Digibridge will accept six digits for R, even though only five will be displayed. The Q is associated with "bin 0", and should be entered as an absolute value again.

Press [3][7][4][.][0][6][=][SHIFT][NOM VALUE]

NOTE: the calibration resistance value should appear in the left display.

Press [.] [0][0][0][0][0][5][=][SHIFT][BIN NO][0]

NOTE: The calibration Q value (first 4 digits only) should appear in the right-hand display.

d. Enable and execute the recalibration for this range as follows. (The following keystrokes are the same for any range.)

Select MEASURE with the [FUNCTION] key and TRIGGERED with [MODE] key.

Press [1][6][5][9][=][1][SHIFT][CALIBRATE]

NOTE: The GO indicator being lit and a 6 in the left and a 6 in the right displays confirm: *calibration is enabled.*

Press START (The GO indicator remains unlit while calibration proceeds.) Keeping hands away from the test fixture, wait until the GO indicator is lit again. This completes recalibration of one range.

e. Check as follows that the Digibridge operates properly with the recalibration.

Select CONTINUOUS with the [MODE] key. The Digibridge should measure the calibration resistor like any ordinary resistor and display its R and Q values. The Q display should indicate f. Also, the NO-GO indicator will probably be lit; this is normal.

f. Disconnect the calibration resistor from the test fixture.

### 5.9.5 Recalibration for Range 2

a. Connect the 5.97-kilohm calibration resistor to the Digibridge test fixture.

b. Select ENTER with [FUNCTION] key and verify that measure MODE is CONT. Press the R/Q key and sequence to the first kW range (as discussed in paragraph 5.9.3) this is range 2.

c. Enter the known parameters of the calibration resistor as in the following example, based on the values R = 5.9581 kilohms and Q = -22 ppm. (NOTES: The Digibridge will accept six digits for R, even though only five will be displayed. The Q is associated with "bin 0", and should be entered as an absolute value again.

Press [5][.][9][5][8][1][=][SHIFT][NOM VALUE]

NOTE: The calibration resistance value should appear in the left display.

Press [-][.][0][0][0][0][2][2][=][SHIFT][BIN NO][0]

NOTE: The calibration Q value (first 4 digits only) should appear in the right-hand display.

d. Enable and execute the recalibration for this range as follows. (The following keystrokes are the same for any range.)

Select MEASURE with the [FUNCTION] key and TRIGGERED with [MODE] key.

Press [1][6][5][9][=][1][SHIFT][CALIBRATE]

NOTE: The GO indicator being lit and a 6 in the left and a 6 in the right displays confirm: *calibration is enabled.*

Press START (The GO indicator remains unlit while calibration proceeds.) Keeping hands away from the test fixture, wait until the GO indicator is lit again. This completes recalibration of one range.

e. Check as follows that the Digibridge operates properly with the recalibration.

Select CONTINUOUS with the [MODE] key.

The Digibridge should measure the calibration resistor like any ordinary resistor and display its R and Q values. The Q display should indicate f. Also, the NO-GO indicator will probably be lit; this is normal.

f. Disconnect the calibration resistor from the test fixture.

### 5.9.6 Recalibration for Range 1

a. Connect the 95.3-kilohm calibration resistor to the Digibridge test fixture.

b. Select ENTER with [FUNCTION] key and verify that measure MODE is CONT. Press the R/Q key and sequence to the second kO range (as discussed in paragraph 5.9.3) this is range 1.

c. Enter the known parameters of the calibration resistor as in the following example, based on the values R = 94.986 kilohms and Q = -280 ppm. (NOTES: The Digibridge will accept six digits for R, even though only five will be displayed. The Q is associated with "bin 0", and should be entered as an absolute value again.

Press [9][4][.][9][8][6][=][SHIFT][NOM VALUE]

NOTE: The calibration resistance value should appear in the left display.

Press [-][.][0][0][2][8][0][=][SHIFT][BIN NO][0]

NOTE: The calibration Q value (first 4 digits only) should appear in the right-hand display.

d. Enable and execute the recalibration for this range as follows. (The following keystrokes are the same for any range.)

Select MEASURE with the [FUNCTION] key and TRIGGERED with [MODE] key.

Press [1][6][5][9][=][1][SHIFT][CALIBRATE]

NOTE: The GO indicator being lit and a 6 in the left and a 6 in the right displays confirm: *calibration is enabled*.

Press START (The GO indicator remains unlit while calibration proceeds.) Keeping hands away from the test fixture, wait until the GO indicator is lit again. This completes recalibration of one range.

e. Check as follows that the Digibridge operates properly with the recalibration.

Select CONTINUOUS with the [MODE] key.

The Digibridge should measure the calibration resistor like any ordinary resistor and display its R and Q values. The Q display can be expected to "jump" a bit. Also, the NO-GO indicator will probably be lit; this is normal.

f. Disconnect the calibration resistor from the test fixture.

### 5.9.7 The K Factor Calibration, a Special Procedure

If you determine (step <sup>NOTE</sup> a below) that K factor calibration is not necessary, skip all of paragraph 5.9.7.

The K factor calibration for each of the four ranges provides a correction for small differences in loading and timing as a function of measurement frequency. This special calibration is NOT REGULARLY INCLUDED IN THE ROUTINE CALIBRATION PROCEDURE DESCRIBED ABOVE, because the corrections determined below, normally kept indefinitely in RAM, do not require updating because of drifts in component and parameter values.

a. Decide whether K factor calibration is needed. It is needed under these conditions:

If battery, or RAM, or ROM has been replaced or disconnected for any reason  
If the RAM standby battery circuit has been serviced.

If K factor calibration is needed, *AND IF YOU HAVE NOT COMPLETED THE CALIBRATION DESCRIBED IN PARAGRAPHS 5.9.2 THROUGH 5.9.6*, do repeat paragraphs 5.9.2 through 5.9.6 now.  
However, if K factor calibration is not needed, skip the rest of paragraph 5.9.7.

b. To reset K factors to nominal values (required as starting references):

1. With the [FUNCTION] key, select ENTER.
2. Press [1][6][5][9][.][9][SHIFT][LOCK][SHIFT].
3. Press [START] (to initiate storage of K factors).

c. Verify that the preceding step was successful, as follows.

1. Press [R/Q]
2. For RANGE 1, press [1][6][5][9][.][5][SHIFT][LOCK][SHIFT]  
The display must be either -238.42 ohms or -.23842 kilohms.
3. For RANGE 2, press [1][6][5][9][.][6][SHIFT][LOCK][SHIFT]  
The display must be either -11.176 ohms or -.01118 kilohms.
4. For RANGE 3, press [1][6][5][9][.][7][SHIFT][LOCK][SHIFT]  
The display must be either 4.6000 ohms or .00460 kilohms.
5. For RANGE 4, press [1][6][5][9][.][8][SHIFT][LOCK][SHIFT]  
The display must be either 5.5879 ohms or .00559 kilohms.

d. Determine the new K factors by performing the following steps (1 through 9) a total of four times, once for each range. In order to calculate the new K factor for each range, this procedure includes measurement of apparent change (delta%) of the corresponding calibration resistor values, due to change of measurement frequency from 1 kHz to 10 kHz.

1. Make these selections:

With the [FUNCTION] key --- ENTER  
With the [MODE] key --- CONTINUOUS  
With the [MEASURE RATE] key --- SLOW  
With the [DISPLAY] key --- VALUE.



2. Set the measurement frequency to 1 kHz, by pressing the following keys repeatedly as may be required, until the I-kHz indicator is lit.

[SHIFT] [FREQUENCY]

3. Select the range to be calibrated by pressing the [R/Q] key several times while observing the displayed units of resistance. Notice that:

The second instance of "kilohms" indicates the selection of range 1.

The first instance of "kilohms" indicates the selection of range 2.

The second instance of "ohms" indicates the selection of range 3.

The first instance of "ohms" indicates the selection of range 4.

4. With the [FUNCTION] key, select MEASURE.

Insert the calibration resistor, as follows, for the range being calibrated.

For range 1: 95 kilohms (see note on resolution, below)

For range 2: 6 kilohms

For range 3: 374 ohms

For range 4: 25 ohms.

Note: If the resolution on range 1 is only 4 digits, press the keys: [L/Q] [R/Q]. The resolution should be 5 digits.

Record the average measured value of the standard resistor, as indicated on the Digibridge display. (For example: for range 1 the I-kHz measurement might be 95.286 Kohm).

5. With the [FUNCTION] key, select ENTER.

Enter as a nominal value the reading noted above.

(Continuing with the former example, you would press the following keys.)

[9][5][.][2][8][6][=][SHIFT][NOM VAL]

6. Set the measurement frequency to 10 kHz, by pressing the following keys repeatedly as may be required, until the IO-kHz indicator is lit.

[SHIFT] [FREQUENCY]

7. With the [FUNCTION] key, select MEASURE.

Record the average measured value of the standard resistor, as indicated on the Digibridge display.

(For example: for range 1 the 10-kHz measurement might be 94.982 Kohm).

8. Calculate delta% (the percentage change in measurement due to frequency), as follows:

$$\text{delta}\% = \frac{(\text{10 kHz measurement, step 7}) - (\text{1 kHz measurement, step 4})}{(\text{1 kHz measurement, step 4})} \times 100$$

Continuing with the example, the calculation might be:

$$\text{delta}\% = \frac{94.982 - 95.286}{95.286} \times 100 = -0.3190$$

9. Calculate the new K factor, using the formula:

$$K_b = \frac{\text{delta}\%}{K_f} + K_a \left( 1 + \frac{\text{delta}\%}{100} \right) \quad \text{where:}$$

$K_b$  = K factor (being calculated)

$\text{delta}\%$  = percentage change in measured value, from 1 kHz to 10 kHz (see step 8)

$K_f$  = "Frequency Factor" = .0003948

$K_a$  = nominal K factor for the range, values (as in step c):

for range 1: -238.42, for range 2: -11.176, for range 3: 4.6000, for range 4: 5.5879

Continuing with the example:

$$K_b = \frac{-0.3190}{.0003948} - 238.42 \left( 1 + \frac{-0.3190}{100} \right) = -1045.66$$

e. Enter and store the new K factors by repeating this step (e) a total of four times, once for each range.

With the [FUNCTION] key, select ENTER.

Press [R/Q] until the ohms indicator is lit.

Enter the new K factor for the range as a nominal value.

Continuing the example for range 1, you would use the following key strokes.

(Note: the Digibridge makes valid use of all 6 digits.)

[−][1][0][4][5][.][6][6][=][SHIFT][NOM VAL]

Store the entered nominal value as the new K factor for the range, as follows:

for range 1, press [1][6][5][9][.][1][=][SHIFT][LOCK][SHIFT]

for range 2, press [1][6][5][9][.][2][=][SHIFT][LOCK][SHIFT]

for range 3, press [1][6][5][9][.][3][=][SHIFT][LOCK][SHIFT]

for range 4, press [1][6][5][9][.][4][=][SHIFT][LOCK][SHIFT]

also, **for each range**, make three selections of [MEASURE RATE] in sequence:

---- MEDIUM then FAST then SLOW. (This step stores the new K factor.)

f. After the new K factors have been determined and stored for all four ranges, i.e., you have completed steps d through e: now repeat the normal recalibration procedure for all ranges, as described in paragraphs 5.9.2 through 5.9.6.

## 5.10 INTERNAL SETTINGS

### 5.10.1 Address for IEEE-488 Interface

Each device (instrument) in a system linked by an IEEE-488 bus must have its own address (except in the simple case of a single "talker only" with one or more "listeners" that are always listening). The initial setting of address, provided by the factory, in the interface option of this Digibridge, is 00011. If the requirements of a system installation make it necessary to change the Digibridge address, use the following procedure. Refer to paragraph 2.8.4 for further comments and a table of possible addresses.

a. Remove the interface option, after removing the 2 large screws with resilient washers in the rear panel. See Figure 1-2.

#### CAUTION

Observe the handling precautions given at the beginning of the Service Section.

b. Find S2 which is located at the end of the interface option board, about 3 cm (1 in.) from the TALK switch S1. If S2 is covered, lift the cover off, exposing the "DIP" switch, which has 2 rows of 6 tiny square pads with numbers 1 thru 6 between the rows. The five device-dependent bits of the address are set by this switch.

c. Set in the desired bits as follows. To enter logical 1's, depress pads nearest the end of the board. To enter logical 0's, depress pads on the other side of the "DIP" switch, the side marked with a + sign. The address is read from 5 to 1 (not using 6). Thus, for example, to set up the address 00011, enter 0's at positions 5, 4, 3; enter 1's at positions 2, 1. (This makes the talk address "C" and the listen address "#".)

NOTE: Strictly speaking, the address includes more; S2 determines only the device-dependent bits of the address. You cannot choose talk and listen addresses separately, only as a pair. The list of possible pairs is shown in Table 2-3. In the above example, the remote message codes MLA and MTA are X0100011 and X1000011, respectively. Thus the listen address and the talk address are distinguished, although they contain the same set of device-dependent bits, which are set into S2.

d. Replace the interface option assembly in its former place. Reassembly note: align board edges carefully with connector and guide that are inside of instrument, while pushing interface option into position.

### 5.10.2 Making +5 Volts Available via the Handler Interface Connector

A five-volt low-power dc bus is normally brought out via pin 10 of the handler interface connector. This bus is useful to supply voltage for opto-couplers in a handler. Do NOT attempt to draw more than 25 mA. The bus is connected via a factory-installed jumper, which is accessible as follows.

a. Remove the interface option, after removing the 2 large screws with resilient washers in the rear panel. See Figure 1-2.

#### CAUTION

Observe the handling precautions given at the beginning of the Service Section.

- b. Find wire tie points WT2 and WT3, on the circuit board, near the handler interface connector.
- c. If the jumper is missing, connect a wire jumper between WT2 and WT3.
- d. Replace the interface option assembly in its former place. Reassembly note: align board edges carefully with connector and guide that are inside of instrument, while pushing interface option into position.

---

# Parts Lists and Diagrams – Section 6

---

6.1	GENERAL	6-1
6.2	REFERENCE DESIGNATIONS	6-1
6.3	DIAGRAMS	6-3
Figure 6-1.	Front View, showing mechanical parts	6-2
Figure 6-2.	Rear View, showing mechanical parts	6-2
	Federal Supply Code for Manufacturers	6-4
Figure 6-3.	Main Board, schematic sheet 1 . . . 1689-4702-01-SD	6-5
Figure 6-4.	Main Board, layout notes . . . . . 1689-4702-01	6-6
Figure 6-5.	Main Board, layout drawing . . . . . 1689-4702-01	6-7
Figure 6-6.	Main Board, schematic sheet 2 . . . 1689-4702-01-SD	6-8
Figure 6-7.	Main Board, schematic sheet 3 . . . 1689-4702-01-SD	6-9
Figure 6-8.	Main Board, schematic sheet 4 . . . 1689-4702-01-SD	6-10
Figure 6-9.	Main Board, schematic sheet 5 . . . 1689-4702-01-SD	6-11
Figure 6-10.	Main Board, schematic sheet 6 . . . 1689-4702-01-SD	6-12
Figure 6-11.	Main Board, schematic sheet 7 . . . 1689-4702-01-SD	6-12
Figure 6-12.	Power Supply, assembly . . . . . 1689-2005	6-13
Figure 6-13.	Power Supply Board, layout . . . . . 1657-4720	6-14
Figure 6-14.	Power Supply, schematic . . . . . 1689-2005-SD	6-14
Figure 6-15.	Display Board, layout . . . . . 1689-4705	6-15
Figure 6-16.	Display Board, schematic, sheet 1 . . . 1689-4705-2D	6-16
Figure 6-17.	Display Board, schematic, sheet 2 . . . 1689-4705-2D	6-17
Figure 6-18.	Interface Option, layout, sheet 1 . . . 1658-4720-1D	6-18
Figure 6-19.	Interface Option, schematic . . . . . 1658-4720-2DA	6-19
Figure 6-20.	Keyboard Module, assembly . . . . . 1687-4200-01	6-20
Figure 6-21.	Keyboard Indicators, detail . . . . . 1687-4710-2D	6-20
Figure 6-22.	Keyboard, schematic . . . . . 1687-4710-2D	6-21

## 6.1 GENERAL

This section contains the parts lists, circuit board layout drawings, and schematic diagrams for the instrument. Refer to Section 4 for the functional block diagram and Section 5 for further details about part locations.

## 6.2 REFERENCE DESIGNATIONS

Each electrical component part on an assembly is identified on the equipment and drawings by means of a reference designator comprised of letters and numbers. Component parts on a circuit board or assembly are classified by the letter or letters of the reference designators (R for resistor, C for capacitor, etc) and individually identified by the numerical part of the reference designator (R1 for the first resistor, R2 for the second, etc). Some of the less obvious designator letters are: DS or CR for indicator light, Q for transistor, U for integrated-circuit device, WT for wire tie point, J or P for connector, and Z for network.

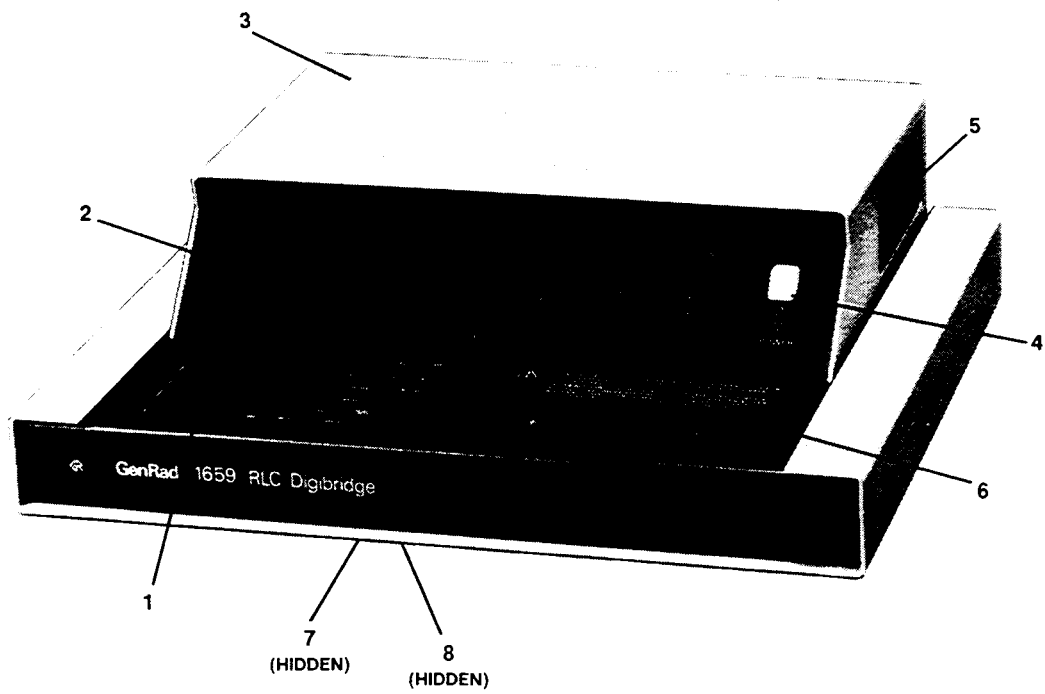

Figure 6-1. Front view of 1659, showing replaceable mechanical parts.

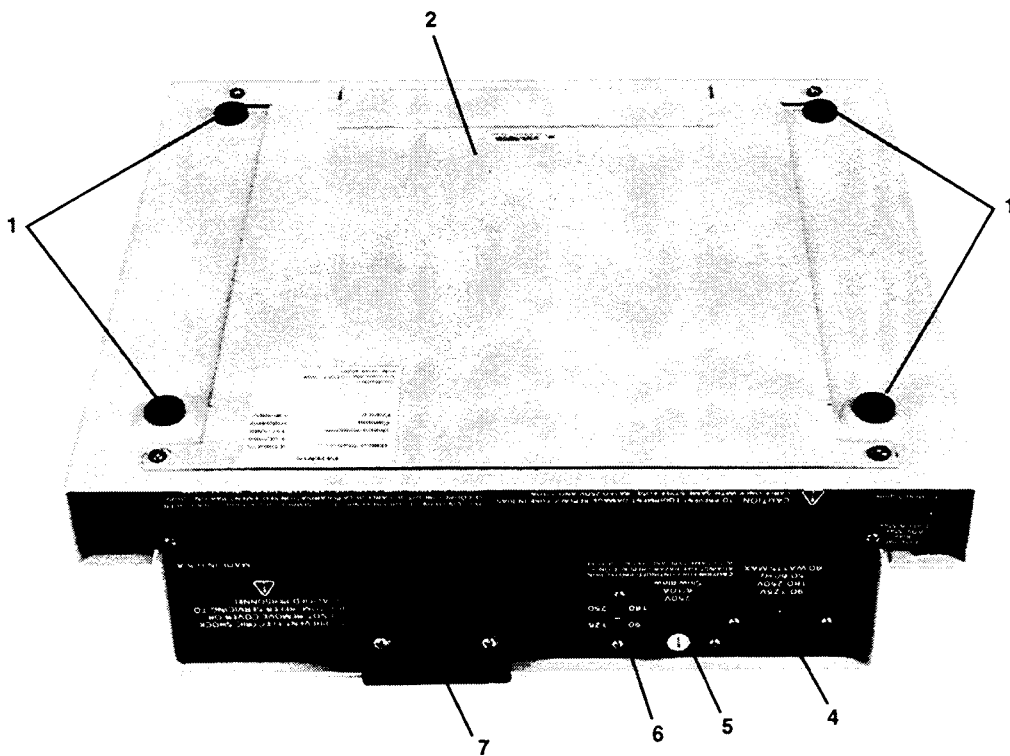

Figure 6-2. Rear view of 1659, showing replaceable mechanical parts.

**MECHANICAL PARTS LIST FOR 1659 DIGmRIDGE~**

Item	Description	GenRad Part	Mftr	Mftr Part No.
1	Keyboard top plate	1659-8040	24655	1659-8040
2	Display panel	1659-8000	24655	1659-8000
3	Top cover	1659-8003	24655	1659-8003
4	Pushbutton	1659-8004	24655	1659-8004
4	Rod	1659-8005	24655	1659-8005
5	Air filter (washable, dry type)	5155-1218	24655	5155-1218
6	Test fixture upper assembly (includes dross tray and foamed plastic pad)	1689-2000 1657-7700 1657-7800	24655 24655 24655	1689-2000 1657-7700 1657-7800
-	Test fixture contacts (4 required; included on 1689-4702 board) each:	1689-1015	24655	1689-1015
7	Card Pan	1658-8200	24655	1658-8200
8	Instruction card	1659-0110	24655	1659-0110

**REAR (Figure 6-2)**

Item	Description	GenRad Part	Mftr	Mftr Part No
1	Foot (4 required) each:	5260-2051	24655	5260-2051
2	Bottom shell (card pan not shown)	1657-8000	24655	1657-8000
3	IEEE/HANDLER interface option shown) Blank plate used if no option present:	1658-8040	24655	1658-8040
4	Power connector J101	4240-0250	82389	EAC-302
5	Fuse extractor post F1	5650-0100	75915	342-004
6	Line voltage switch S2	7910-0832	82389	11A-1266
7	Cover (over transistor U1)	1657-8120	24655	1657-8120

**6.3 DIAGRAMS**

In this section, the schematic diagrams are located on right-hand fold-out pages for convenience. The associated parts list, layout drawing, assembly view, etc for each schematic diagram are located on the apron of the same page, the facing page, or otherwise nearby.





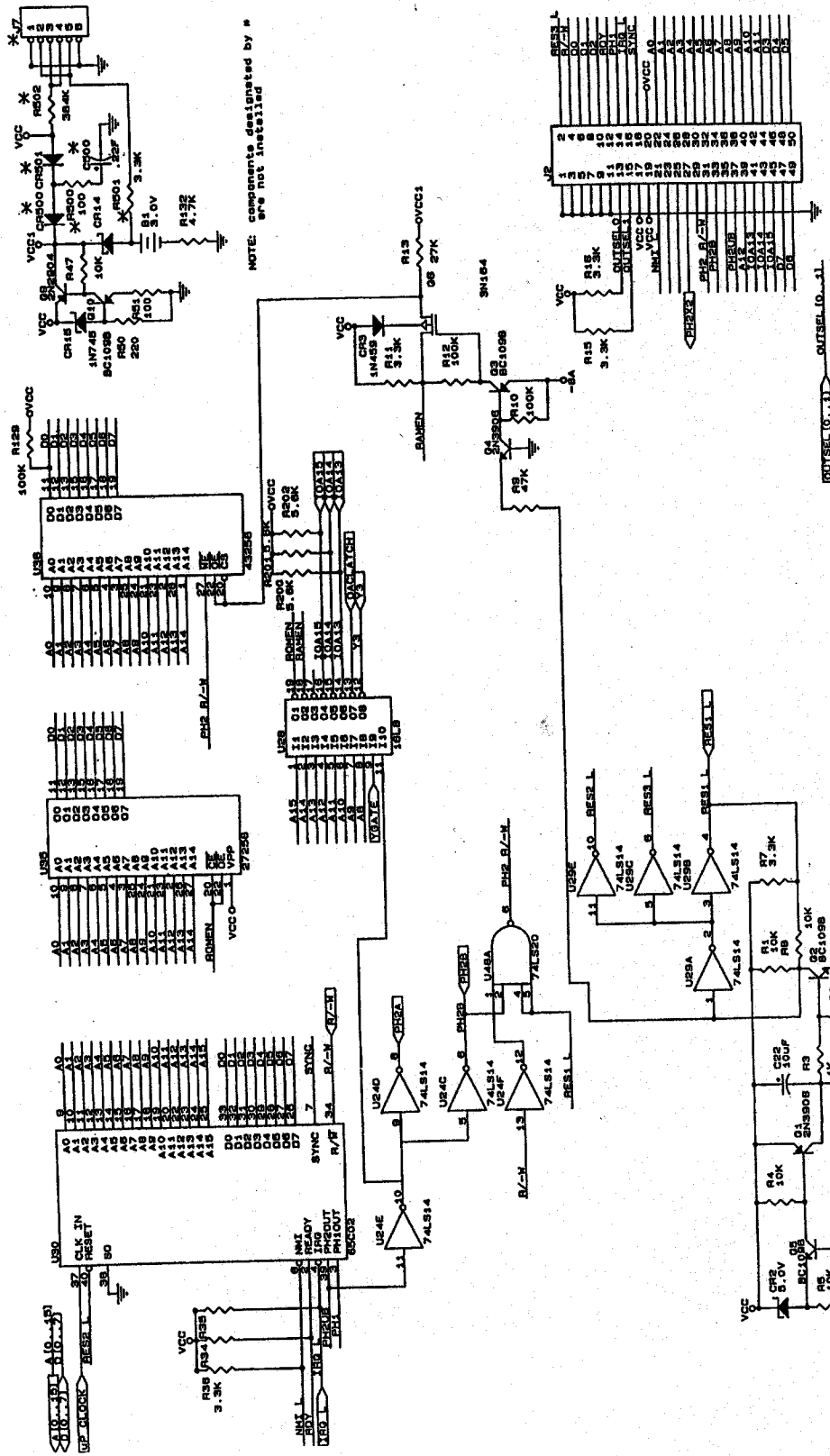

NOTE: components designated by \* are not installed

PROPRIETARY: THIS DOCUMENT CONTAINS PROPRIETARY DATA OF GENRAD, INC. NO DISCLOSURE, REPRODUCTION, OR USE OF ANY PART THEREOF MAY BE MADE EXCEPT BY WRITTEN PERMISSION

Figure 6-3. Main Board, schematic sheet 1, 1689-4702-01-SD

PARTS LISTS AND DIAGRAMS 6-5





RefDesig	Description	Part Number
R89-80	RES CARBON FILM 220OHM 5% 1/4W	6099-1225-00
R91	CFLM 3.3K 5% 1/4W	6099-2333-00
R92	CFLM 5.6K 5% 1/4W	6099-2566-00
R93	CARBON FILM 220OHM 5% 1/4W	6099-1222-00
R94	CFLM 10K 5% 1/4W	6099-3109-00
R95	CARBON FILM 220OHM 5% 1/4W	6099-1222-00
R96	CFLM 1.0M 5% 1/4W	6250-0469-00
R97	CFLM 15K 5% 1/4W	6099-3105-00
R98	CFLM 10K 5% 1/4W	6099-3105-00
R99	CFLM 10K 5% 1/4W	6099-3105-00
R100	CFLM 10K 5% 1/4W	6099-3105-00
R101	CFLM 10K 5% 1/4W	6099-3105-00
R102	CFLM 10K 5% 1/4W	6099-3105-00
R103	CFLM 10K 5% 1/4W	6099-3105-00
R104	CFLM 10K 5% 1/4W	6099-3105-00
R105	CFLM 10K 5% 1/4W	6099-3105-00
R106	CFLM 10K 5% 1/4W	6099-3105-00
R107	CFLM 10K 5% 1/4W	6099-3105-00
R108	CFLM 10K 5% 1/4W	6099-3105-00
R109	CFLM 10K 5% 1/4W	6099-3105-00
R110	CFLM 10K 5% 1/4W	6099-3105-00
R111	CFLM 10K 5% 1/4W	6099-3105-00
R112	CFLM 10K 5% 1/4W	6099-3105-00
R113	CFLM 10K 5% 1/4W	6099-3105-00
R114	CFLM 10K 5% 1/4W	6099-3105-00
R115	CFLM 10K 5% 1/4W	6099-3105-00
R116	CFLM 10K 5% 1/4W	6099-3105-00
R117	CFLM 10K 5% 1/4W	6099-3105-00
R118	CFLM 10K 5% 1/4W	6099-3105-00
R119	CFLM 10K 5% 1/4W	6099-3105-00
R120	CFLM 10K 5% 1/4W	6099-3105-00
R121	CFLM 10K 5% 1/4W	6099-3105-00
R122	CFLM 10K 5% 1/4W	6099-3105-00
R123	CFLM 10K 5% 1/4W	6099-3105-00
R124	CFLM 10K 5% 1/4W	6099-3105-00
R125	CFLM 10K 5% 1/4W	6099-3105-00
R126	CFLM 10K 5% 1/4W	6099-3105-00
R127	CFLM 10K 5% 1/4W	6099-3105-00
R128	CFLM 10K 5% 1/4W	6099-3105-00
R129	CFLM 10K 5% 1/4W	6099-3105-00
R130	CFLM 10K 5% 1/4W	6099-3105-00
R131	CFLM 10K 5% 1/4W	6099-3105-00
R132	CFLM 10K 5% 1/4W	6099-3105-00
R133	CFLM 10K 5% 1/4W	6099-3105-00
R134	CFLM 10K 5% 1/4W	6099-3105-00
R135	CFLM 10K 5% 1/4W	6099-3105-00
R136	CFLM 10K 5% 1/4W	6099-3105-00
R137	CFLM 10K 5% 1/4W	6099-3105-00
R138	CFLM 10K 5% 1/4W	6099-3105-00
R139	CFLM 10K 5% 1/4W	6099-3105-00
R140	CFLM 10K 5% 1/4W	6099-3105-00
R141	CFLM 10K 5% 1/4W	6099-3105-00
R142	CFLM 10K 5% 1/4W	6099-3105-00
R143	CFLM 10K 5% 1/4W	6099-3105-00
R144	CFLM 10K 5% 1/4W	6099-3105-00
R145	CFLM 10K 5% 1/4W	6099-3105-00
R146	CFLM 10K 5% 1/4W	6099-3105-00
R147	CFLM 10K 5% 1/4W	6099-3105-00
R148	CFLM 10K 5% 1/4W	6099-3105-00
R149	CFLM 10K 5% 1/4W	6099-3105-00
R150	CFLM 10K 5% 1/4W	6099-3105-00
R151	CFLM 10K 5% 1/4W	6099-3105-00
R152	CFLM 10K 5% 1/4W	6099-3105-00
R153	CFLM 10K 5% 1/4W	6099-3105-00
R154	CFLM 10K 5% 1/4W	6099-3105-00
R155	CFLM 10K 5% 1/4W	6099-3105-00
R156	CFLM 10K 5% 1/4W	6099-3105-00
R157	CFLM 10K 5% 1/4W	6099-3105-00
R158	CFLM 10K 5% 1/4W	6099-3105-00
R159	CFLM 10K 5% 1/4W	6099-3105-00
R160	CFLM 10K 5% 1/4W	6099-3105-00
R161	CFLM 10K 5% 1/4W	6099-3105-00
R162	CFLM 10K 5% 1/4W	6099-3105-00
R163	CFLM 10K 5% 1/4W	6099-3105-00
R164	CFLM 10K 5% 1/4W	6099-3105-00
R165	CFLM 10K 5% 1/4W	6099-3105-00
R166	CFLM 10K 5% 1/4W	6099-3105-00
R167	CFLM 10K 5% 1/4W	6099-3105-00
R168	CFLM 10K 5% 1/4W	6099-3105-00
R169	CFLM 10K 5% 1/4W	6099-3105-00
R170	CFLM 10K 5% 1/4W	6099-3105-00
R171	CFLM 10K 5% 1/4W	6099-3105-00
R172	CFLM 10K 5% 1/4W	6099-3105-00
R173	CFLM 10K 5% 1/4W	6099-3105-00
R174	CFLM 10K 5% 1/4W	6099-3105-00
R175	CFLM 10K 5% 1/4W	6099-3105-00
R176	CFLM 10K 5% 1/4W	6099-3105-00
R177	CFLM 10K 5% 1/4W	6099-3105-00
R178	CFLM 10K 5% 1/4W	6099-3105-00
R179	CFLM 10K 5% 1/4W	6099-3105-00
R180	CFLM 10K 5% 1/4W	6099-3105-00
R181	CFLM 10K 5% 1/4W	6099-3105-00
R182	CFLM 10K 5% 1/4W	6099-3105-00
R183	CFLM 10K 5% 1/4W	6099-3105-00
R184	CFLM 10K 5% 1/4W	6099-3105-00
R185	CFLM 10K 5% 1/4W	6099-3105-00
R186	CFLM 10K 5% 1/4W	6099-3105-00
R187	CFLM 10K 5% 1/4W	6099-3105-00
R188	CFLM 10K 5% 1/4W	6099-3105-00
R189	CFLM 10K 5% 1/4W	6099-3105-00
R190	CFLM 10K 5% 1/4W	6099-3105-00
R191	CFLM 10K 5% 1/4W	6099-3105-00
R192	CFLM 10K 5% 1/4W	6099-3105-00
R193	CFLM 10K 5% 1/4W	6099-3105-00
R194	CFLM 10K 5% 1/4W	6099-3105-00
R195	CFLM 10K 5% 1/4W	6099-3105-00
R196	CFLM 10K 5% 1/4W	6099-3105-00
R197	CFLM 10K 5% 1/4W	6099-3105-00
R198	CFLM 10K 5% 1/4W	6099-3105-00
R199	CFLM 10K 5% 1/4W	6099-3105-00
R200	CFLM 10K 5% 1/4W	6099-3105-00
R201	CFLM 10K 5% 1/4W	6099-3105-00
R202	CFLM 10K 5% 1/4W	6099-3105-00
S01	SURGE ARRESTOR 110V 20% BV	4230-8141-00
TP1	CON PC3MILE POST 025SQ.10X.23L	4260-0850-00
U1	ICD SN74LS161N 16 SYN4BITPROCNT	5431-8761-00
U2	ICD SN74LS161N 16 SYN4BITPROCNT	5431-8761-00
U3	ICD SN74LS161N 16 SYN4BITPROCNT	5431-8761-00
U4	ICD SN74LS161N 16 SYN4BITPROCNT	5431-8761-00
U5	ICD SN74LS161N 16 SYN4BITPROCNT	5431-8761-00
U6	ICD SN74LS161N 16 SYN4BITPROCNT	5431-8761-00
U7	ICD SN74LS161N 16 SYN4BITPROCNT	5431-8761-00
U8	ICD SN74LS161N 16 SYN4BITPROCNT	5431-8761-00
U9	ICD SN74LS161N 16 SYN4BITPROCNT	5431-8761-00
U10	ICD SN74LS161N 16 SYN4BITPROCNT	5431-8761-00
U11	ICD SN74LS161N 16 SYN4BITPROCNT	5431-8761-00
U12	ICD SN74LS161N 16 SYN4BITPROCNT	5431-8761-00
U13	ICD SN74LS161N 16 SYN4BITPROCNT	5431-8761-00
U14	ICD SN74LS161N 16 SYN4BITPROCNT	5431-8761-00
U15	ICD SN74LS161N 16 SYN4BITPROCNT	5431-8761-00
U16	ICD SN74LS161N 16 SYN4BITPROCNT	5431-8761-00
U17	ICD SN74LS161N 16 SYN4BITPROCNT	5431-8761-00
U18	ICD SN74LS161N 16 SYN4BITPROCNT	5431-8761-00
U19	ICD SN74LS161N 16 SYN4BITPROCNT	5431-8761-00
U20	ICD SN74LS161N 16 SYN4BITPROCNT	5431-8761-00

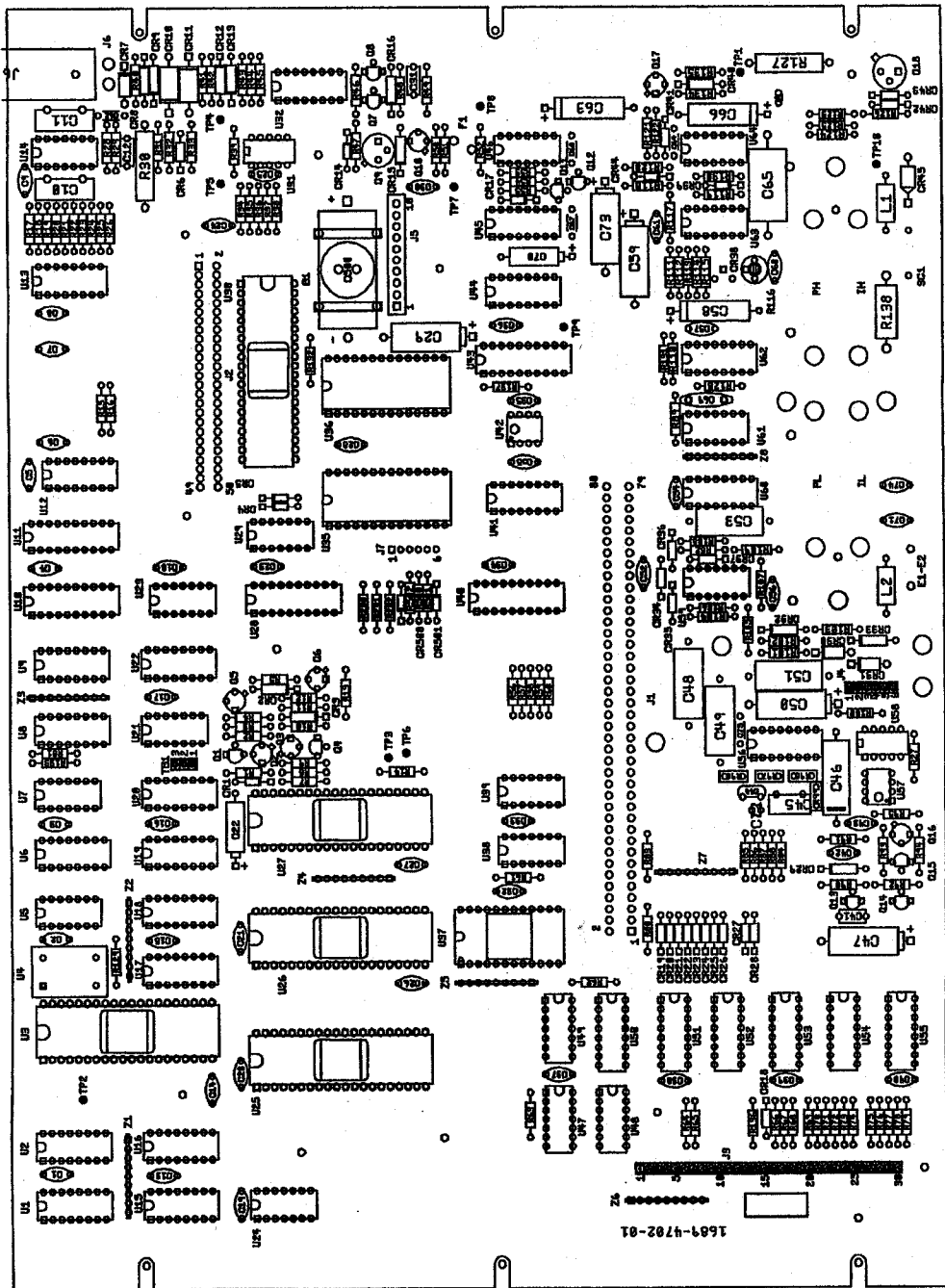

Figure 6-5. Main Board, layout drawing, 1689-4702-01





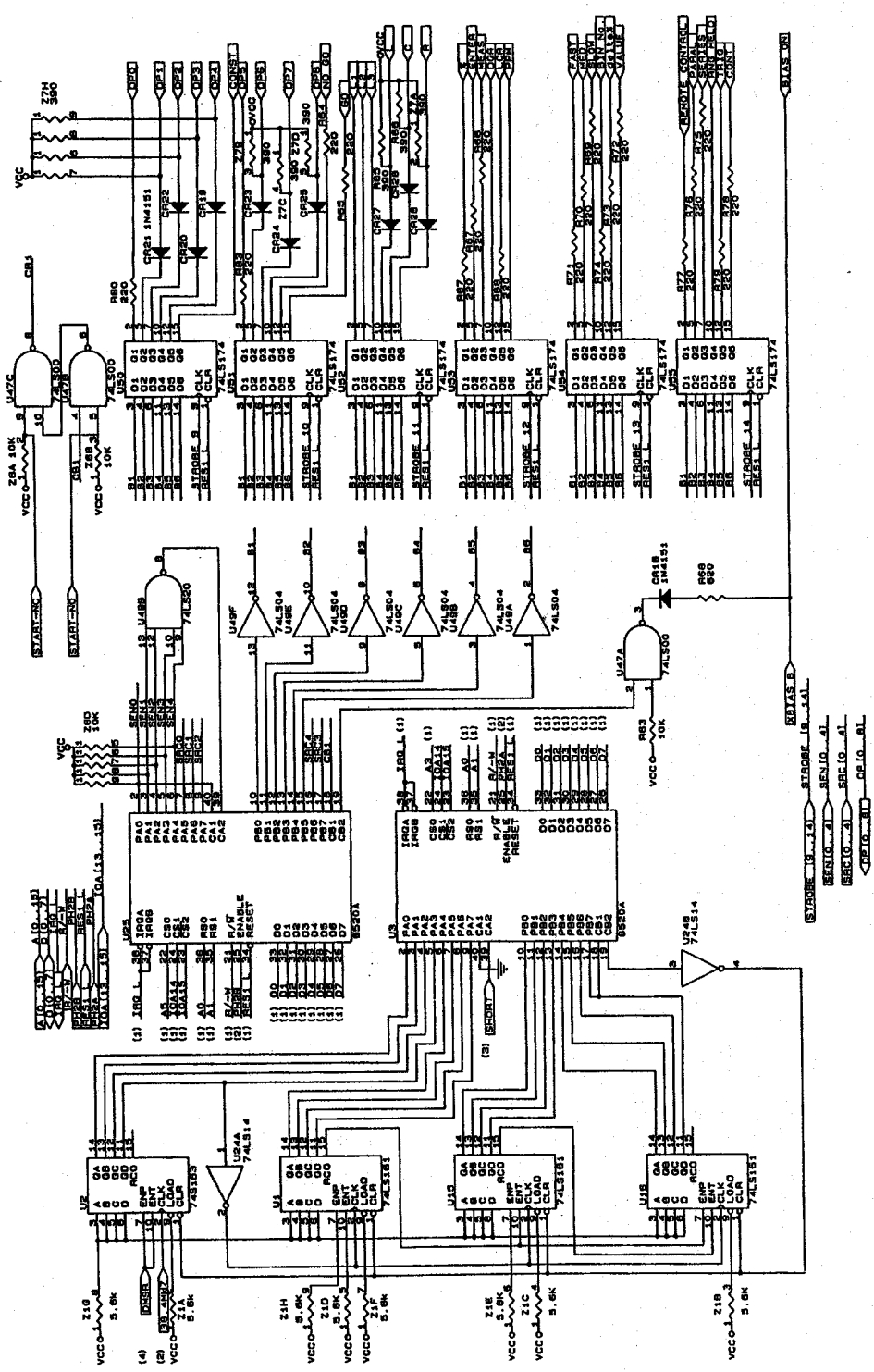

Figure 6-9. Main Board, schematic sheet 5, 1689-4702-01-SD

PARTS LISTS AND DIAGRAMS 6-11

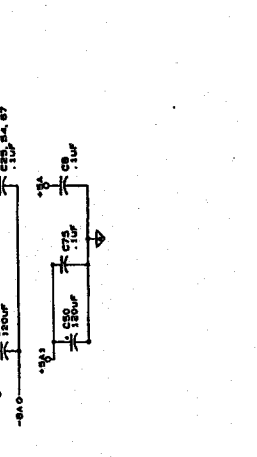
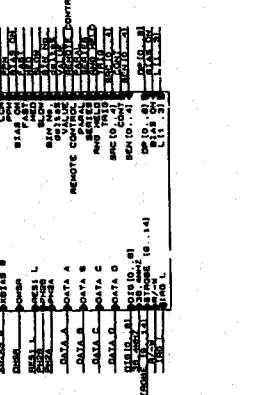
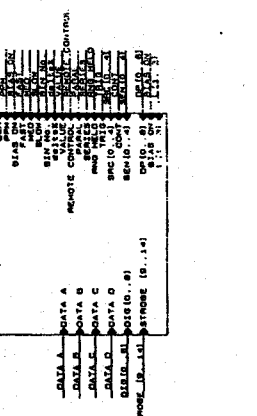
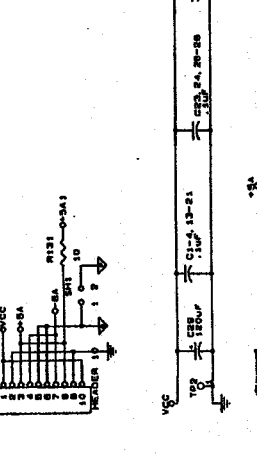
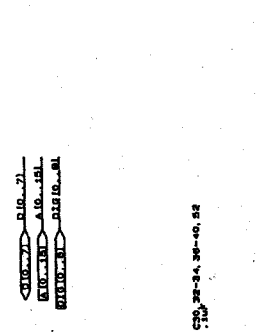
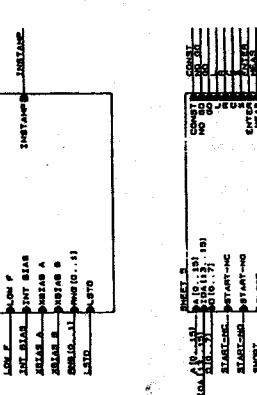
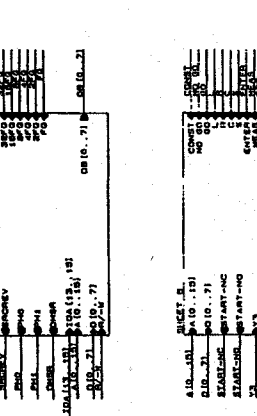
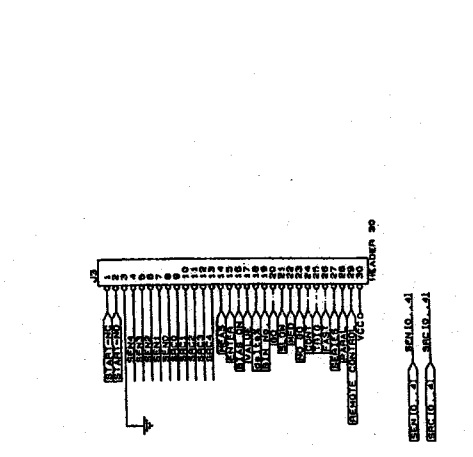
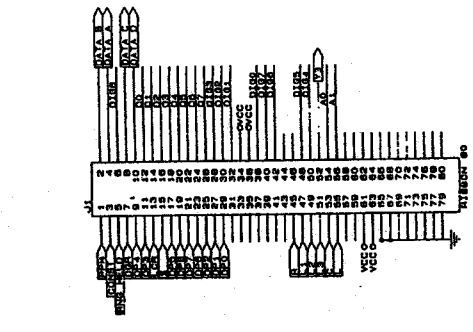
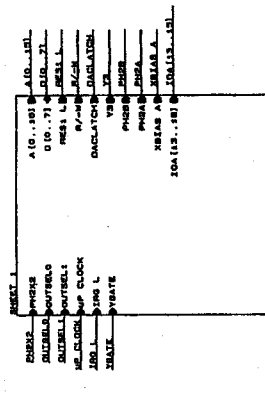
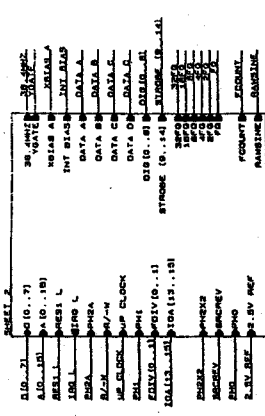

Figure 6-11. Main Board, schematic sheet 7, 1689-4702-01-SD

6-12 PARTS LISTS AND DIAGRAMS

Figure 6-10. Main Board, schematic sheet 6, 1689-4702-01-SD





ELECTRICAL PARTS LISTS

POWER SUPPLY BOARD P/N 1857-4720

REFDES	DESCRIPTION	PART NO.	FMC	MFR PART NUMBER
C 3	CAP TANT 1.0 UF 20PCT 35V	4450-4300	56289	150015000035A2
C 7	CAP TANT 1.0 UF 20PCT 35V	4450-4300	56289	150015000035A2
C 8	CAP CER MCMO .01 UF 50V S	4400-4301	72382	8121-1A050-WSR-103K
C 9	CAP CER MCMO .01 UF 10PCT 50V S	4400-4351	72382	8121-1A050-WSR-103K
C 11	CAP TANT 1.0 UF 20PCT 35V	4450-4300	56289	150015000035A2
CR 5	DIODE RECTIFIER 1N4003	6081-1001	14433	1N4003
CR 6	DIODE RECTIFIER 1N4003	6081-1001	14433	1N4003
CR 7	DIODE RECTIFIER 1N4003	6081-1001	14433	1N4003
CR 8	DIODE RECTIFIER 1N4003	6081-1001	14433	1N4003
CR 9	RECT 1N4140 100RV 3A SI ADM	6081-1014	14433	1N4140
CR 10	RECT 1N4140 100RV 3A SI ADM	6081-1014	14433	1N4140
S 1	SWITCH PUSH PUSH AC UL 6A	7870-1570	24655	7870-1570
U 3	IC LINEAR LM424P-5	5432-1466	12040	LM424P-5
U 3	IC LINEAR LM424P-5	5432-1466	12040	LM424P-5

ELECTRICAL PARTS LISTS

POWER SUPPLY ASM	DESCRIPTION	PART NO.	FMC	MFR PART NUMBER
CR 1	CAP ALUM 18000 UF 20V	4450-4231	24655	4450-4231
C 2	CAP ALUM 4500 UF 40V	4450-4231	90201	4450-4231
C 5	CAP TANT 1.0 UF 20PCT 35V	4450-4300	56289	150015000035A2
C 6	CAP TANT 1.0 UF 20PCT 35V	4450-4300	56289	150015000035A2
F 1	FUSE SLO-BLOW 810A 250V	5330-1100	75915	313-800
J 101	RECEPTACLE POWER UL STN 15A250V	4240-0250	82389	EAC-302
S 2	SWITCH SLIDE 2 PO DPST STEADY S	7910-0802	82389	11A-1286
T 1	TRANSFORMER POWER	0485-4095	24655	0485-4095
U 1	ICL 78H05SC TO-3 POS 5V REG	5432-1466	07263	UA78H05SC

NOTE: THIS ASSEMBLY INCLUDES CIRCUIT BOARD 1857-4720

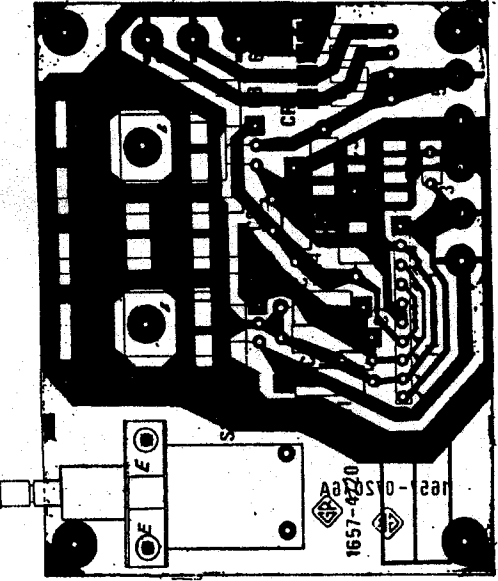
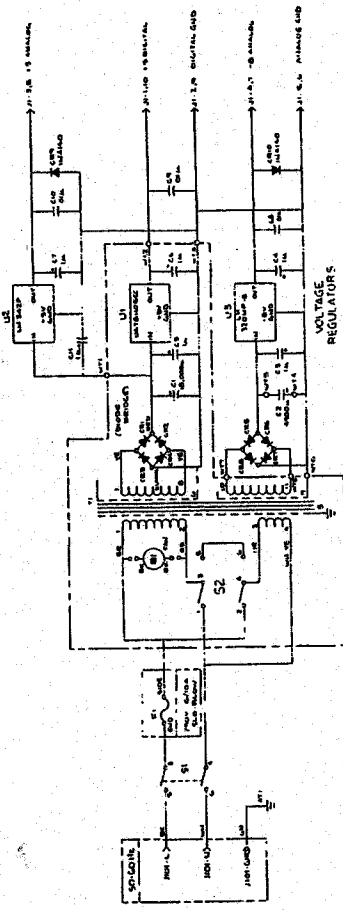

Figure 6-13. Power Supply Board, layout, 1857-4720



NOTE: COMPONENTS INSIDE OF PARALLEL LINEAR REGULATOR ARE NOT SHOWN. THESE COMPONENTS ARE PART OF THE REGULATOR IC. THE REGULATOR IC IS A SEPARATE PART. THE REGULATOR IC IS A SEPARATE PART. THE REGULATOR IC IS A SEPARATE PART.

Figure 6-14. Power Supply, schematic, 1859-2005-S1

Figure 6-15. Display Board, layout, 1689-1705

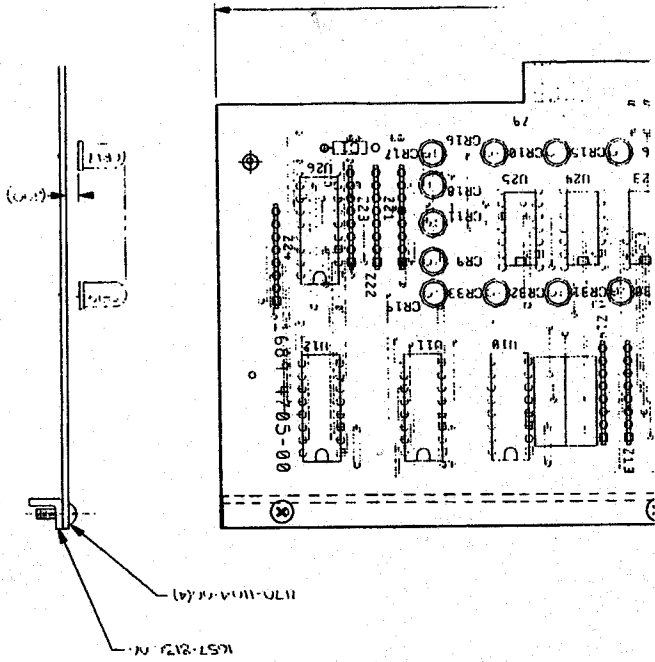

- NOTES:
1. BARE BOARD NO. 1689-0705-00 REV. 02
  2. BOARD VIEW FROM COMPONENT SIDE
  3. CIRCUITARY SHOWN, REPRESENTS COMPONENT SIDE.
  4. CONTACT FINGERS, IF APPLICABLE, ARE TO BE FREE OF SOLDER AND ADHESIVE.
  5. SQUARE PAD ■ DENOTES THE FOLLOWING:
    - POSITIVE + END OF CAPACITORS
    - ROTOR OF TRIMMER CAPACITORS
    - ARM OF POTENTIOMETERS
    - COLLECTOR OF TRANSISTERS
    - CATHODE END OF DIODES
    - PN # OF IC'S RELAYS AND CONNECTORS.
  6. U15-25 TO BE INSTALLED INTO SOCKETS 7540-1814-00 AFTER WAVE SOLDERING.



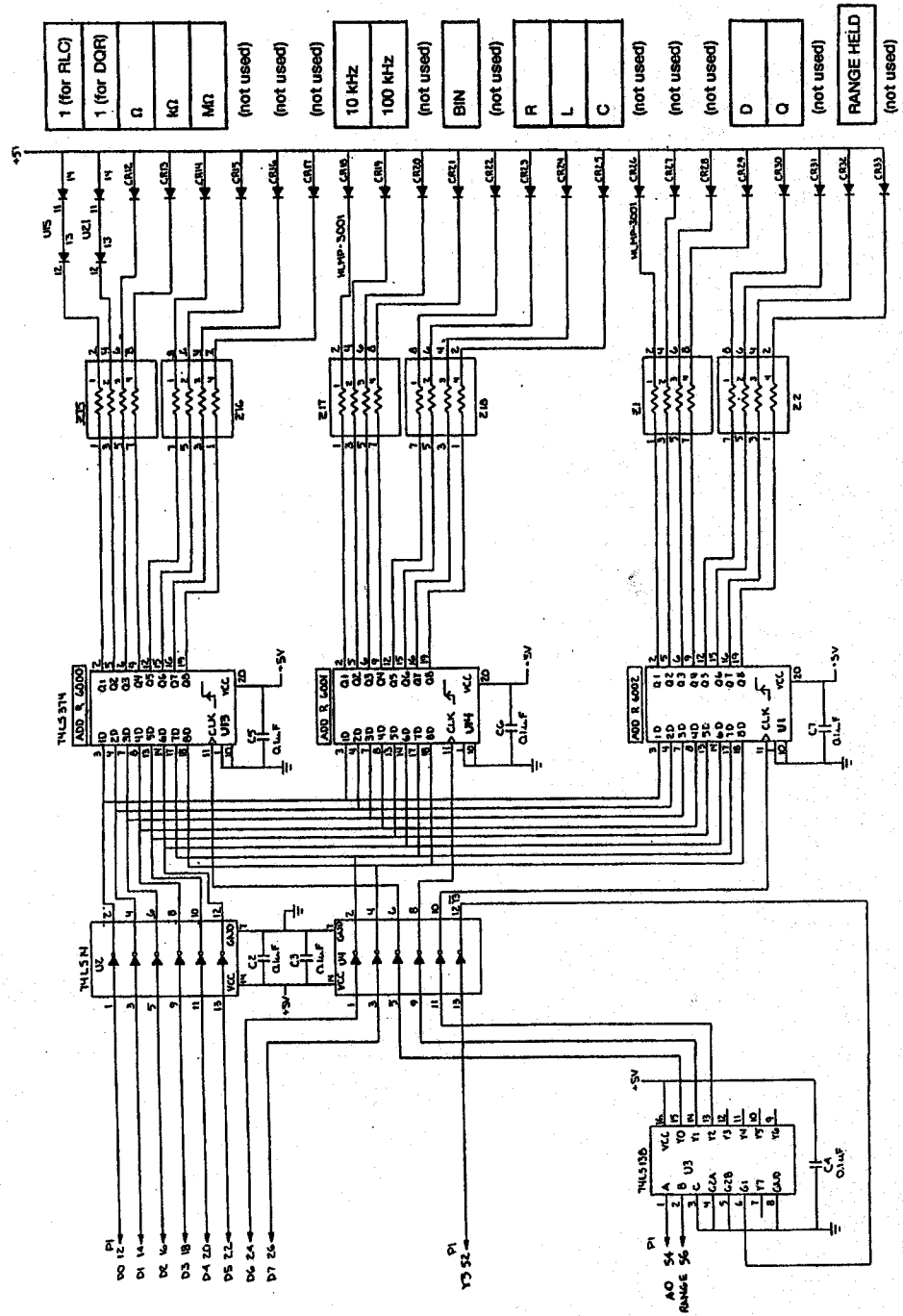

Figure 6-17. Display Board, schematic, sheet 2, 1689-4705-2D  
PARTS LISTS AND DIAGRAMS 6-17

ELECTRICAL PARTS LISTS

INTERFACE OPTION ASM	P/N 1658-1020	PART NO.	FMC	MFR PART NUMBER
REPT MICRO RIB 24 CONT	4230-4824	02660	02660	57-40240
CONAI PNL 24REN CONT MICRO RIB	4230-4824	02660	02660	57-40240-2

NOTE: THIS ASSEMBLY INCLUDES CIRCUIT BOARD 1658-4720

ELECTRICAL PARTS LISTS

INTERFACE OPTION BOARD	P/N 1658-4720	DESCRIPTION	PART NO.	FMC	MFR PART NUMBER
CR	1	DIODE RECTIFIER 1N4003	6081-1001	14433	1N4003
R	1	RES COMP 3.3K SPTCT 1/4W	6006-2035	81348	RCR070332J
R	2	RES COMP 3.3K SPTCT 1/4W	6006-2335	81348	RCR070332J
R	3	RES COMP 3.3K SPTCT 1/4W	6006-2335	81348	RCR070332J
R	4	RES COMP 3.3K SPTCT 1/4W	6006-2335	81348	RCR070332J
R	5	RES COMP 3.3K SPTCT 1/4W	6006-3105	81348	RCR070332J
R	6	RES COMP 10K SPTCT 1/4W	6006-3105	81348	RCR070332J
R	7	RES COMP 3.3K SPTCT 1/4W	6006-2335	81348	RCR070332J
R	8	RES COMP 3.3K SPTCT 1/4W	6006-2335	81348	RCR070332J
S	2	SWITCH TOGGLE 6STA. SPTCT PC	7810-3030	31514	1006-852
U	12	SWITCH TOGGLE PC PKCT STEADY	7810-1620	64462	16801
U	1	KD (STATIC PROTECT REC)	5431-2450	04713	MC5821
U	2	KD DM8007	5431-2685	12040	DM8007
U	3	KD DM8007	5431-2685	12040	DM8007
U	4	KD DM8007	5431-2685	12040	DM8007
U	5	KD DM8007	5431-2685	12040	DM8007
U	6	KD MCG341	5431-8604	01256	SN74LSM4N
U	7	KD MCG341	5431-8604	01256	SN74LSM4N
U	8	KD MCG341	5431-8604	01256	SN74LSM4N
U	9	KD MCG341	5431-8604	01256	SN74LSM4N
U	10	KD MCG341	5431-8604	01256	SN74LSM4N
U	11	KD MCG341	5431-8604	01256	SN74LSM4N
U	12	KD (STATIC PROTECT REC)	5431-2450	04713	MC5821

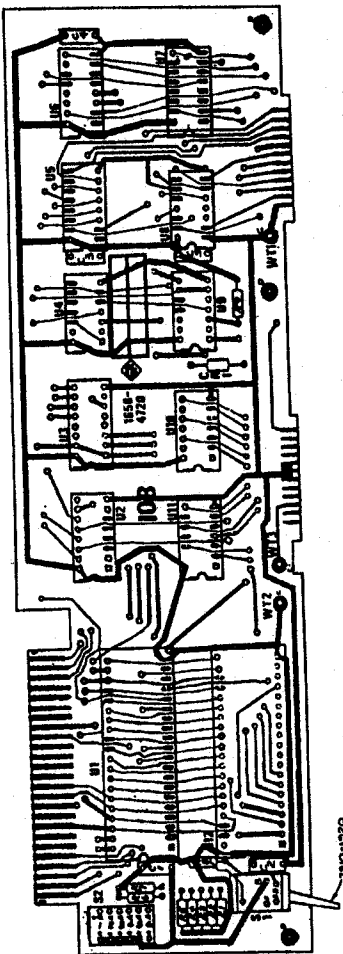

Figure 6-18. Interface Option Board, layout, 1658-4720-1D

6-18 PARTS LISTS AND DIAGRAMS

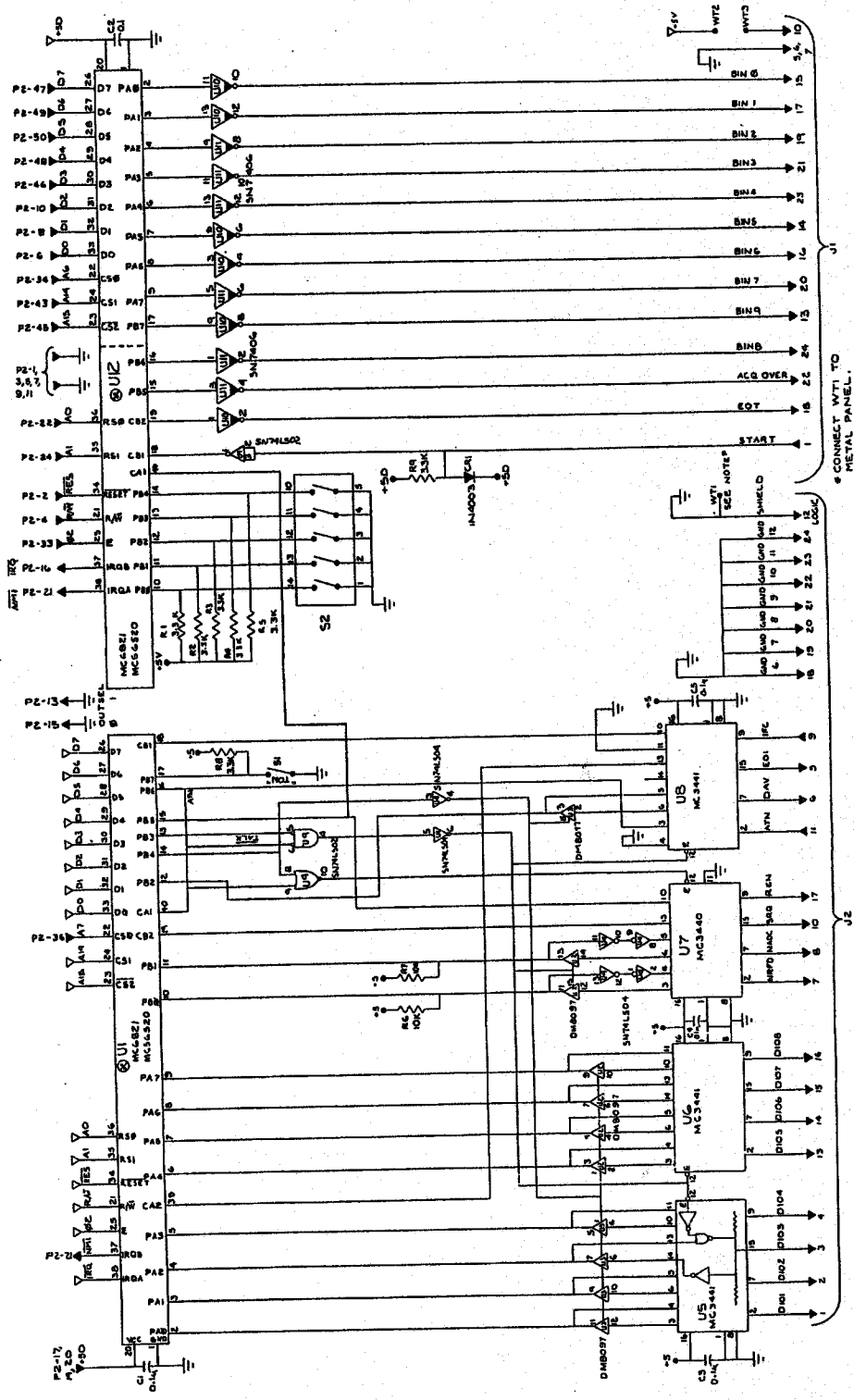

Figure 6-19. Interface Option, schematic, 1658-4720-2DA  
PARTS LISTS AND DIAGRAMS 6-19

**CAUTION**  
THE FOLLOWING COMPONENTS  
REQUIRE SPECIAL HANDLING  
FOR STATIC PROTECTION  
REFER TO CSMA-SH01-P1  
U1, U2

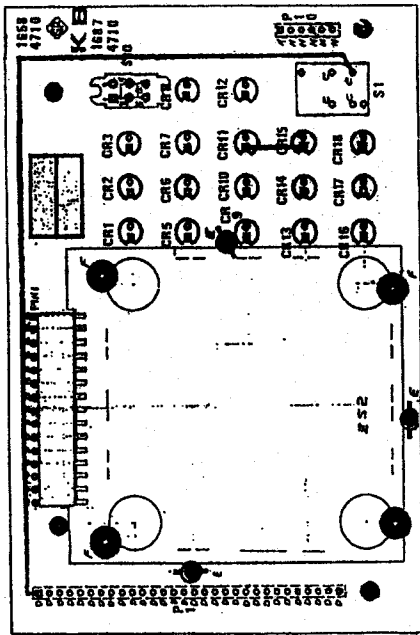

Figure 8-21. Keyboard Indicators, detail, 1687-4710-1D

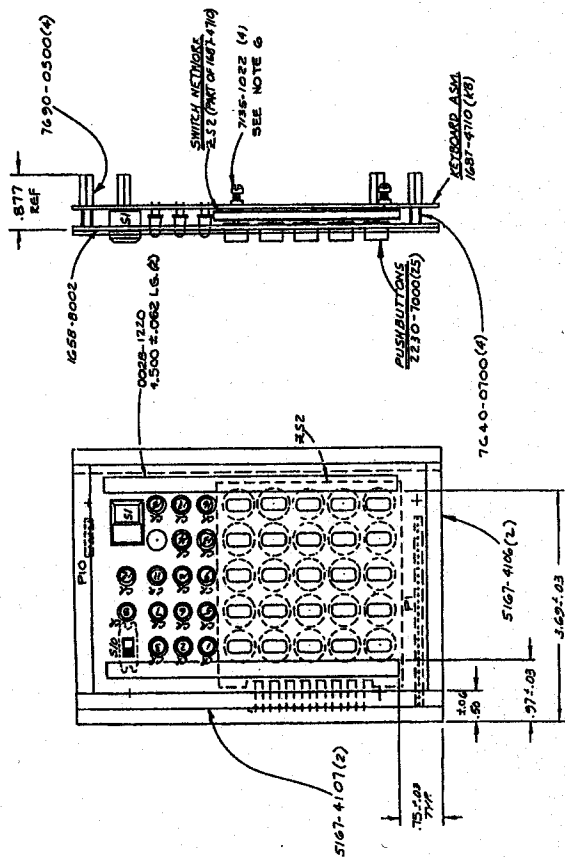

Figure 8-20. Keyboard Module, assembly, 1687-4200



ELECTRICAL PARTS LISTS

KEYBOARD ASM KB	P/N 1687-4710	DESCRIPTION	PART NO.	PMC	MFR PART NUMBER
CR 1	LED RED	MY5023	6084-1104	71744	GM-23
CR 2	LED RED	MY5023	6084-1104	71744	GM-23
CR 3	LED RED	MY5023	6084-1104	71744	GM-23
CR 4	LED RED	MY5023	6084-1104	71744	GM-23
CR 5	LED RED	MY5023	6084-1104	71744	GM-23
CR 6	LED RED	MY5023	6084-1104	71744	GM-23
CR 7	LED RED	MY5023	6084-1104	71744	GM-23
CR 8	LED RED	MY5023	6084-1104	71744	GM-23
CR 9	LED RED	MY5023	6084-1104	71744	GM-23
CR 10	LED RED	MY5023	6084-1104	71744	GM-23
CR 11	LED RED	MY5023	6084-1104	71744	GM-23
CR 12	LED RED	MY5023	6084-1104	71744	GM-23
CR 13	LED RED	MY5023	6084-1104	71744	GM-23
CR 14	LED RED	MY5023	6084-1104	71744	GM-23
CR 15	LED RED	MY5023	6084-1104	71744	GM-23
CR 16	LED RED	MY5023	6084-1104	71744	GM-23
CR 17	LED RED	MY5023	6084-1104	71744	GM-23
CR 18	LED RED	MY5023	6084-1104	71744	GM-23
P 10	CONN 20 P/N .025 SQ POST		4230-8085	30146	82947-02-20
S 1	SWITCH PUSH MOUNT DPT		4230-8086	30146	82947-02-06
S 10	SWITCH PUSH MOUNT DPT STEADY		7870-5E71	31818	TYPE BR BLACK
ZS 2	SWITCH PUSHBUTTON MULTY KEYBOARD		7810-0470	10389	ZS-021-118
			7860-3200	24655	7860-3200

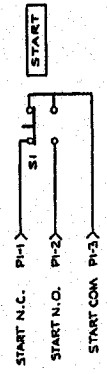
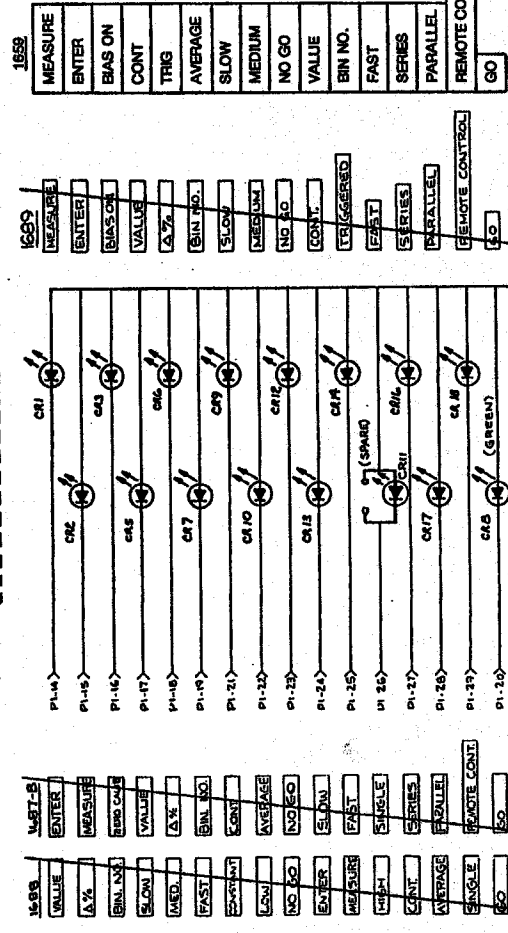
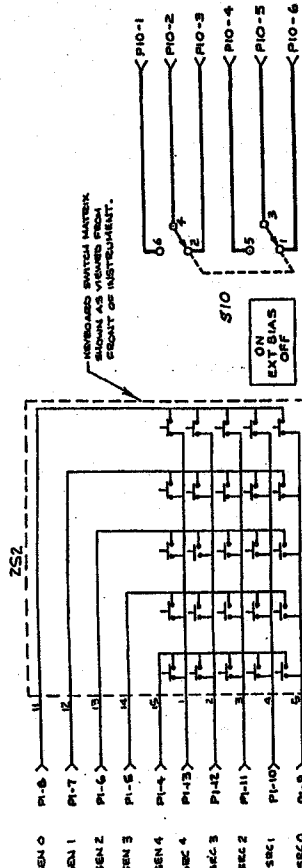

Figure 6-22. Keyboard, schematic, 1687-4710-2D  
PARTS LISTS AND DIAGRAMS 6-31